

Operating Manual

Translation of the Original Operating Manual

UF V (E3)

Ultra Low Temperature Freezers with RD4 Controller

Model	Model version	Art. No.	Voltage
UF V			
UF V 350	UFV350-230V	9020-0453, 9120-0453	230 V
UF V 500	UFV500-230V	9020-0347, 9120-0347	230 V
UF V 700	UFV700-230V	9020-0348, 9120-0348	230 V
UF V-UL			
UF V 350	UFV350UL-120V	9020-0454, 9120-0454	120 V
UF V 350	UFV350UL-240V	9020-0455, 9120-0455	208-240 V
UF V 500-UL	UFV500UL-120V	9020-0351, 9120-0351	120 V
UF V 500-UL	UFV500UL-240V	9020-0353, 9120-0353	208-240 V
UF V 700-UL	UFV700UL-120V	9020-0352, 9120-0352	120 V
UF V 700-UL	UFV700UL-240V	9020-0354, 9120-0354	208-240 V
UF V with water cooling			
UF V 500	UFV500-230V-H2O	9020-0349, 9120-0349	230 V
UF V 700	UFV700-230V-H2O	9020-0350, 9120-0350	230 V

BINDER GmbH

- ▶ Address: Post office box 102, 78502 Tuttlingen, Germany ▶ Phone: +49 7462 2005 0
- ▶ Fax: +49 7462 2005 100 ▶ Internet: <http://www.binder-world.com>
- ▶ Service Hotline: +49 7462 2005 555
- ▶ Service Fax: +49 7462 2005 93 555
- ▶ Service Hotline USA: +1 866 885 9794 or +1 631 224 4340 x3
- ▶ Service Hotline Asia Pacific: +852 390 705 04 or +852 390 705 03

Contents

1. SAFETY	6
1.1 Personnel Qualification	6
1.2 Operating manual	6
1.3 Legal considerations	6
1.3.1 Intellectual property	7
1.4 Structure of the safety instructions	7
1.4.1 Signal word panel	7
1.4.2 Safety alert symbol	8
1.4.3 Pictograms	8
1.4.4 Word message panel structure	9
1.5 Localization / position of safety labels at the chamber	9
1.6 Type plate	10
1.7 UKCA Label	12
1.8 General safety instructions on installing and operating the chamber	12
1.9 Intended use	14
1.10 Foreseeable Misuse	16
1.11 Residual Risks	16
1.12 Operating instructions	18
1.13 Measures to prevent accidents	18
2. CHAMBER DESCRIPTION	19
2.1 Chamber overview	21
2.2 Door lock and controller housing	23
2.2.1 Operating the NumPad (option "Door access system" for UF V 500 and UF V 700)	24
2.2.2 Operating the electromechanical door locking (option "Door access system" for UF V 500 and UF V 700)	24
2.3 Main power switch	25
2.4 Chamber rear	26
2.5 Doors	27
2.5.1 Outer door	27
2.5.2 Compartment doors	27
2.5.3 Operating the door lock (option "Lockable door handle")	28
2.6 Drain well for condensate during defrosting (option)	28
3. COMPLETENESS OF DELIVERY, TRANSPORTATION, STORAGE, AND INSTALLATION	29
3.1 Unpacking, and checking equipment and completeness of delivery	29
3.2 Guidelines for safe lifting and transportation	30
3.2.1 Moving the freezer inside a building	30
3.2.2 Transport outside a building	31
3.3 Storage	32
3.4 Location of installation and ambient conditions	32
4. INSTALLATION AND CONNECTIONS	34
4.1 Operating instructions	34
4.2 Spacers for rear wall distance	34
4.3 Support feet (UF V 350 only)	34
4.4 Adjustable shelves	35
4.5 Connections of cooling water for chambers with water cooling	37
4.5.1 Connection of cooling water outlet for water cooling	37
4.5.2 Connection of cooling water inlet for water cooling	38
4.5.3 Connection kit for cooling water	38
4.6 Electrical connection	40
4.7 Advanced voltage booster (option)	40

5.	FUNCTIONAL OVERVIEW OF THE RD4 CHAMBER CONTROLLER	41
5.1	Menu structure of the controller and access levels	42
6.	START UP	43
6.1	Preset factory parameters	43
6.2	Behavior after turning on the chamber	43
7.	TEMPERATURE SET-POINT ENTRY	44
8.	PLACING SAMPLES IN STORAGE IN THE FREEZER	45
9.	SETTING SPECIAL CONTROLLER FUNCTIONS	46
10.	PASSWORD	47
10.1	Password request	47
10.2	Assign and modify a password	47
10.2.1	Assign and modify the User password	48
10.2.2	Assign and modify the Admin password	48
10.3	Performance during and after power failure and shut down	49
11.	SAFETY CONTROLLER (TEMPERATURE SAFETY DEVICE)	49
11.1	Setting the safety controller mode	50
11.2	Setting the safety controller value	50
11.3	Message and measures in the state of alarm	51
11.4	Function check	51
12.	GENERAL CONTROLLER SETTINGS	52
12.1	Selecting the controller's menu language	52
12.2	Selecting the temperature unit	52
12.3	Setting the current date	53
12.4	Setting the current time	54
12.5	Function "Language selection at restart"	54
12.6	Setting the chamber address	55
12.7	Display brightness	55
13.	TOLERANCE RANGE AND ALARM DELAY SETTINGS	56
13.1	Setting the delay time for door open alarm	56
13.2	Setting the delay time for tolerance range alarm	56
13.3	Setting the temperature tolerance range	57
14.	ALARM FUNCTIONS	58
14.1	Alarm messages	58
14.2	Information messages	60
14.3	Activating / deactivating the audible alarm (alarm buzzer)	60
14.4	Required actions in case of an alarm	61
14.4.1	Safety controller temperature alarm	61
14.4.2	Temperature tolerance range alarm (too high and too low temperature)	61
14.4.3	Door open alarm	62
14.4.4	Power failure alarm (chamber with option "battery-buffered alarm system")	62
14.4.5	Messages on the battery management system (chamber with option "battery-buffered alarm system")	63
14.4.6	Messages referring to temperature sensor failure	64
14.4.7	Messages referring to CO ₂ emergency cooling (option CO ₂ emergency cooling)	65
14.5	Zero-voltage relay alarm output	66
15.	ETHERNET NETWORK SETTINGS	67
15.1	Showing the network settings	67
15.1.1	Showing the chamber's MAC address	67
15.1.2	Showing the IP address	67

15.1.3	Showing the subnet mask	68
15.1.4	Showing the standard gateway	68
15.1.5	Showing the DNS server address	68
15.1.6	Showing the DNS chamber name	69
15.2	Changing the configuration of the network settings	69
15.2.1	Selecting the type of IP address assignment (automatic / manual)	69
15.2.2	Selecting the type of assignment of the DNS server address (automatic / manual).....	70
15.2.3	Assigning the IP address.....	70
15.2.4	Setting the subnet mask.....	71
15.2.5	Setting the standard gateway	71
15.2.6	Assigning the DNS server address	72
16.	ACCESS CODES (OPTION “DOOR ACCESS SYSTEM” FOR UF V 500 AND UF V 700)	72
16.1	Assigning the access codes.....	72
16.2	Opening the chamber door with the access code.....	73
17.	DATA RECORDER	74
17.1	Recorded data.....	74
17.2	Storage capacity	75
17.3	Setting the storage rate for the “DL1” recorder data	75
17.4	Deleting the data recorder.....	75
18.	USB-MENU: DATA TRANSFER VIA USB INTERFACE	76
18.1	Connecting the USB stick	76
18.2	Import function	76
18.3	Export functions	77
18.4	Ongoing data transfer	77
18.5	Error during data transmission.....	78
18.6	Removing the USB stick	78
19.	BATTERY MANAGEMENT SYSTEM (OPTION “BATTERY-BUFFERED ALARM SYSTEM”)	78
19.1	Battery operation.....	78
19.2	Charging voltage	79
20.	SETTING AND ACTIVATING THE SERVICE SETPOINT	79
20.1	Setting the service setpoint.....	79
20.2	Activating the service setpoint.....	80
21.	CO₂ EMERGENCY COOLING (OPTION)	81
21.1	Connecting and exchanging the pressurized CO ₂ cylinder.....	82
21.2	Operating the CO ₂ emergency cooling system	84
21.3	Settings on the chamber controller	85
21.3.1	Setting the CO ₂ emergency cooling temperature setpoint	85
21.3.2	Activating the CO ₂ emergency cooling	86
21.3.3	Test run of the CO ₂ emergency cooling	87
22.	DATA MONITORING AND RECORDING	88
22.1	Ethernet interface	88
22.2	APT-COM™ 4 Multi Management Software (option).....	88
22.3	Analog output for temperature (option)	88
23.	CHAMBER INVENTORY: STORAGE RACK SYSTEMS AND CRYO BOXES (OPTION).....	89
23.1	Storage rack systems with or without cryo boxes	89
23.2	Cryo boxes	89

24. CLEANING AND DECONTAMINATION	90
24.1 Cleaning	90
24.2 Decontamination / chemical disinfection	92
25. MAINTENANCE AND SERVICE, SERVICE, TROUBLESHOOTING, REPAIR, TESTING	93
25.1 General information, personnel qualification.....	93
25.2 Maintenance work by the customer	94
25.2.1 Checking and cleaning / replacing the condenser air filter.....	94
25.2.2 Cleaning the condenser.....	95
25.2.3 De-icing and defrosting.....	95
25.2.4 Maintenance of the door lock	96
25.3 Simple troubleshooting.....	96
25.4 Maintenance intervals, service.....	98
25.5 Service Reminder.....	99
25.6 Sending the chamber back to BINDER GmbH	99
26. DISPOSAL.....	100
26.1 Disposal of the transport packing.....	100
26.2 Decommissioning.....	100
26.3 Disposal of the chamber in the Federal Republic of Germany	101
26.4 Disposal of the chamber in the member states of the EU except for the Federal Republic of Germany.....	102
26.5 Disposal of the chamber in non-member states of the EU	103
27. TECHNICAL DESCRIPTION.....	104
27.1 Factory calibration and adjustment	104
27.2 Over current protection	104
27.3 Technical data.....	104
27.4 Equipment and options (extract).....	107
27.5 Optional equipment, accessories and spare parts (extract)	108
27.6 Dimensions of UF V 350 (E3)	110
27.7 Dimensions of UF V 500 (E3)	111
27.8 Dimensions of UF V 700 (E3)	112
28. CERTIFICATES AND DECLARATIONS OF CONFORMITY.....	113
28.1 EU Declaration of Conformity.....	113
28.2 UKCA Declaration of Conformity	115
28.3 Certificate for the GS mark of conformity of the “VDE Prüf- und Zertifizierungsinstitut” (Testing and Certification Institute of the Association for Electrical, Electronic and Information Technologies) ..	116
28.4 Certificate of UL Compliance from Underwriters Laboratories Inc.®.....	117
29. CONTAMINATION CLEARANCE CERTIFICATE	118
29.1 For chambers located outside the USA and Canada	118
29.2 For chambers in the USA and Canada	121

Dear Customer,

For the correct operation of the ultra-low temperature freezer UF V, it is important that you read this operating manual completely and carefully and observe all instructions as indicated. Failure to read, understand and follow the instructions may result in personal injury. It can also lead to damage to the chamber and/or poor equipment performance.

1. Safety

1.1 Personnel Qualification



The chamber must only be installed, tested, and started up by personnel qualified for assembly, startup, and operation of the chamber. Qualified personnel are persons whose professional education, knowledge, experience and knowledge of relevant standards allow them to assess, carry out, and identify any potential hazards in the work assigned to them. They must have been trained and instructed, and be authorized, to work on the chamber.

The chamber should only be operated by laboratory personnel especially trained for this purpose and familiar with all precautionary measures required for working in a laboratory. Observe the national regulations on minimum age of laboratory personnel.

1.2 Operating manual

This operating manual is part of the components of delivery. Always keep it handy for reference in the vicinity of the chamber. If selling the unit, hand over the operating manual to the purchaser.

To avoid injuries and damage observe the safety instructions of the operating manual. Failure to follow instructions and safety precautions can lead to significant risks.

	<div style="background-color: red; color: white; padding: 5px; text-align: center;">  DANGER </div> <p>Dangers due to failure to observe the instructions and safety precautions. Serious injuries and chamber damage. Risk of death.</p> <ul style="list-style-type: none"> ➤ Observe the safety instructions in this Operating Manual. ➤ Follow the operating procedures in this Operating Manual. ➤ Carefully read the complete operating instructions of the chamber prior to installing and using the chamber. ➤ Keep the operating manual for future reference
---	---

	<p>Make sure that all persons who use the chamber and its associated work equipment have read and understood the Operating Manual.</p>
---	--

This Operating Manual is supplemented and updated as needed. Always use the most recent version of the Operating Manual. When in doubt, call the BINDER Service Hotline for information on the up-to-date-ness and validity of this Operating Manual.

1.3 Legal considerations

This operating manual is for informational purposes only. It contains information for correct and safe installing, start-up, operation, decommissioning, cleaning and maintenance of the product. Note: the contents and the product described are subject to change without notice.

Understanding and observing the instructions in this operating manual are prerequisites for hazard-free use and safety during operation and maintenance. Images are to provide basic understanding. They may deviate from the actual version of the chamber. The actual scope of delivery can, due to optional or special design, or due to recent technical changes, deviate from the information and illustrations in these instructions this operating manual. In no event shall BINDER be held liable for any damages, direct or incidental arising out of or related to the use of this manual.

This operating manual cannot cover all conceivable applications. If you would like additional information, or if special problems arise that are not sufficiently addressed in this manual, please ask your dealer or contact us directly, e.g. by phone at the number located on page one of this manual

Furthermore, we emphasize that the contents of this operating manual are not part of an earlier or existing agreement, description, or legal relationship, nor do they modify such a relationship. All obligations on the part of BINDER derive from the respective purchase contract, which also contains the entire and exclusively valid statement of warranty administration and the general terms and conditions, as well as the legal regulations valid at the time the contract is concluded. The statements in this manual neither augment nor restrict the contractual warranty provisions.

1.3.1 Intellectual property

This operating manual is protected by copyright. Any unauthorized copying or disclosure to third parties is strictly prohibited. We reserve the right to take legal action and, if necessary, to assert claims for damages in the event of infringement.

Trademark Information: All BINDER trademarks relating to products or service, as well as trade names, logos and product names used on the website, products and documents of BINDER company are trademarks or registered trademarks of BINDER company (including BINDER GmbH, BINDER Inc.) in the U.S. and other countries and communities of states. This includes word marks, position marks, word/figurative marks, design configurations, figurative marks, and design patents.

Patent Information: BINDER products, categories of products, and accessories may be covered by one or more patents and/or utility models in the U.S. and other countries and communities of states. This information is provided to satisfy the virtual patent marking provisions of various jurisdictions, in particular it is intended to serve as notice under 35 U.S.C. § 287(a). Products and services listed on the BINDER website may be sold individually or as part of a combination product. Additional patent applications may also be pending in the U.S. and other countries and communities of states.

Please visit www.binder-world.com for more information.

1.4 Structure of the safety instructions

In this operating manual, the following safety definitions and symbols indicate dangerous situations in accordance with the standards ISO 3864-2 and ANSI Z535.6.

1.4.1 Signal word panel

Depending on the probability of serious consequences, potential dangers are identified with a signal word, the corresponding safety color, and if appropriate, the safety alert symbol.

 DANGER
Indicates an imminently hazardous situation that, if not avoided, will result in death or serious (irreversible) injury.

 WARNING
Indicates a potentially hazardous situation which, if not avoided, could result in death or serious (irreversible) injury

CAUTION

Indicates a potentially hazardous situation which, if not avoided, may result in moderate or minor (reversible) injury

NOTICE

Indicates a potentially hazardous situation which, if not avoided, may result in damage to the product and/or its functions or of a property in its proximity.

1.4.2 Safety alert symbol



Use of the safety alert symbol indicates a **risk of injury**.

Observe all measures that are marked with the safety alert symbol in order to avoid death or injury.

1.4.3 Pictograms

Warning signs			
Electrical hazard	Very cold surface	Explosive atmosphere	Stability hazard
CO ₂ suffocation hazard	Gas cylinders	Pollution Hazard	Harmful substances
Biohazard	Risk of corrosion and / or chemical burns		
Mandatory action signs			
Mandatory regulation	Read operating instructions	Disconnect the power plug	Lift with mechanical assistance
Environment protection	Wear protective gloves	Wear safety goggles	
Prohibition signs			
Do NOT touch	Do NOT spray with water	Do NOT climb	



Information to be observed in order to ensure optimum function of the product.

1.4.4 Word message panel structure

Type / cause of hazard.





Possible consequences.

- ∅ Instruction on how to avoid the hazard: prohibition
- Instruction on how to avoid the hazard: mandatory action

Observe all other notes and information not necessarily emphasized in the same way, in order to avoid disruptions that could result in direct or indirect injury or property damage.

1.5 Localization / position of safety labels at the chamber

The following labels are located on the chamber:

Pictograms (Warning signs)	Information
 <p>Very cold surface: Risk of freezing</p>	 <p>Energy Star Symbol (only UL chambers)</p>
 <p>Risk of injury. Observe the safety instructions in the operating manual.</p>	 <p>Flammable refrigerants (only UL chambers)</p>
Service label	
	

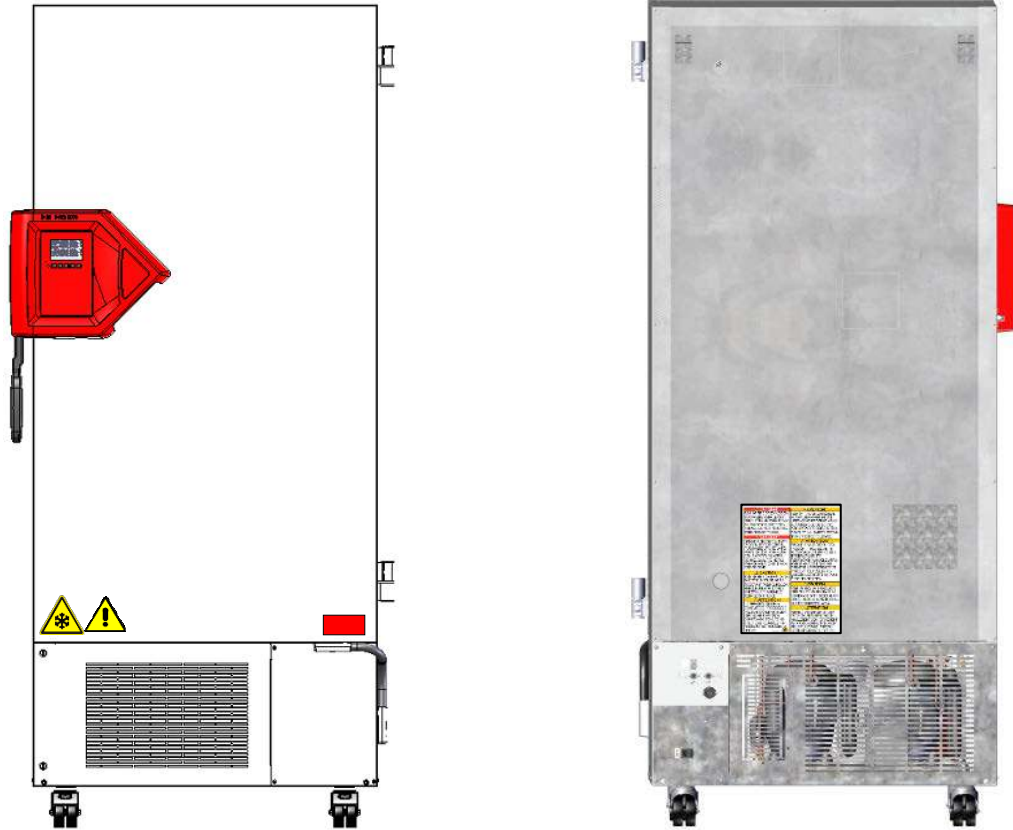

UF V with optional CO₂ emergency cooling

UF V-UL, rear view

Figure 1: Position of labels on the ultra-low temperature freezer UF V



Keep safety labels complete and legible.

Replace safety labels that are no longer legible. Contact BINDER Service for these replacements.

1.6 Type plate

The type plate sticks to the left side of the chamber, bottom right-hand.

Nominal temp.	-90 °C -130 °F	1,60 kW / 9,0 A 230 V / 50 Hz		Max. operating pressure 28 bar Stage 1: R290– 0,150 kg Stage 2: R170 – 0,150 kg Contains hydrocarbon gases
IP protection	20			
Safety device	DIN 12880	1 N ~		
Class	3.1			
Art. No.	9020-0347			
Project No.		ULT Freezer UF V 500		
Built	2022			
		BINDER GmbH Im Mittleren Ösch 5 78532 Tuttlingen / Germany www.binder-world.com	E3	Serial No. 0000000000000 Made in Germany

Figure 2: UF V type plate (example UF V 500 (E3) standard chamber)







Figure 3: UF V-UL type plate (example UF V 500-UL (E3) standard chamber)

Indications of the type plate (example)

Indication		Information
BINDER		Manufacturer: BINDER GmbH
ULT Freezer		Device name: ultra-low temperature freezer
UF V 500		Model designation
Serial No.	000000000000	Serial no. of the chamber
Built	2022	Year of construction
Nominal temperature	-90 °C -130 °F	Nominal temperature
IP protection	20	IP type of protection acc. to standard EN 60529
Temp. safety device	DIN 12880	Temperature safety device acc. to standard DIN 12880
Class	---	Class of temperature safety device
Art. No.	9020-0347	Art. no. of the chamber
Project No.	---	Optional: Special application acc. to project no.
1,60 kW		Nominal power
9,0 A		Nominal current
230 V / 50 Hz		Nominal voltage +/- 10% at the indicated power frequency
1 N ~		Current type
Max. operating pressure 28 bar		Max operating pressure in the refrigerating system
Stage 1: R290 – 0,15 kg		Cooling 1 st stage: Refrigerant type, filling weight
Stage 2: R170 – 0,15 kg		Cooling 2 nd stage: Refrigerant type, filling weight
Contains hydrocarbon gases		Contains hydrocarbon gases

Symbols on the type plate

Symbol	Applies to	Information
	All models	CE conformity marking
	All models	Electrical and electronic equipment manufactured / placed on the market in the EU after 13 August 2005 and to be disposed of in a separate collection according to directive 2012/19/EU on waste electrical and electronic equipment (WEEE).
	Not valid for UL chambers. Not valid for UF V 350	The chamber is certified according to Customs Union Technical Regulation (CU TR) for the Eurasian Economic Union (Russia, Belarus, Armenia, Kazakhstan Kyrgyzstan).

Symbol	Applies to	Information
	Not valid for UL chambers. Not valid for UF V 350	GS mark of conformity of the “VDE Prüf- und Zertifizierungsinstitut” (Testing and Certification Institute of the Association for Electrical, Electronic and Information Technologies) Note: Chambers equipped with the optional CO ₂ emergency cooling do not bear the GS mark.
	UL chambers only	The chamber is certified by Underwriters Laboratories Inc.® according to the following standards: <ul style="list-style-type: none"> • UL 61010-1, 3rd Edition, 2012-05, Rev. 2016-04 • UL 61010-2-011, 1st Edition, 2017-01 • CAN/CSA-C22.2 No. 61010-1, 3rd Edition, 2012-05, Rev. 2016-04 Note: Chambers equipped with the optional CO ₂ emergency cooling do not bear the cUL test mark.

1.7 UKCA Label

The sticker with UKCA Authorised Representative details sticks next to the type plate to the left side of the chamber, bottom right-hand.



Figure 4: UKCA Label

Symbol on the sticker

Symbol	Applies to	Information
	All models except UL models	UKCA conformity marking

1.8 General safety instructions on installing and operating the chamber

With regard to operating the chamber and to the installation location, please observe the local and national regulations relevant for your country (for Germany: DGUV guidelines 213-850 on safe working in laboratories, issued by the employers' liability insurance association).



BINDER GmbH is only responsible for the safety features of the chamber provided skilled electricians or qualified personnel authorized by BINDER perform all maintenance and repair, and if components relating to chamber safety are replaced in the event of failure with original spare parts.

To operate the chamber, use only original BINDER accessories or accessories from third-party suppliers authorized by BINDER. The user is responsible for any risk caused by using unauthorized accessories.



NOTICE	
	<p>Danger of overheating due to lack of ventilation. Damage to the chamber.</p> <ul style="list-style-type: none"> ⊘ Do NOT install the chamber in unventilated recesses. ➤ Ensure sufficient ventilation for dispersal of the heat. ➤ Observe the prescribed minimum distances when installing the chamber (chap. 3.4)

	NOTICE
	<p>Danger to the environment by leakage of refrigerant in the event of a chamber defect.</p> <p>Alteration of the environment.</p> <ul style="list-style-type: none"> ➤ Ensure sufficient ventilation of the installation site.

Do not operate the chamber in hazardous locations.



	 DANGER
	<p>Danger of explosion due to combustible dusts or explosive mixtures in the vicinity of the chamber.</p> <p>Serious injury or death from burns and / or explosion pressure.</p> <ul style="list-style-type: none"> ⊘ Do NOT operate the chamber in potentially explosive areas. ➤ KEEP combustible dust or air-solvent mixtures AWAY from the chamber.



The chamber does not dispose of any measures of explosion protection.

	 DANGER
	<p>Danger of explosion due to introduction of flammable or explosive substances in the chamber.</p> <p>Serious injury or death from burns and / or explosion pressure.</p> <ul style="list-style-type: none"> ⊘ Do NOT introduce any substance into the chamber which is combustible or explosive at working temperature. ⊘ Do NOT introduce any combustible dust or air-solvent mixture in the inner chamber.

Any solvent contained in the charging material must not be explosive or inflammable. I.e., irrespective of the solvent concentration in the steam room, NO explosive mixture with air must form. The temperature inside the chamber must lie below the flash point or below the sublimation point of the charging material. Familiarize yourself with the physical and chemical properties of the charging material.



Familiarize yourself with any potential health risks caused by the charging material. Take adequate measures to exclude any risk prior to putting the chamber into operation.



 	 WARNING
	<p>Danger of intoxication and infection through contamination of the chamber with toxic, infectious or radioactive substances.</p> <p>Damages to health.</p> <ul style="list-style-type: none"> ➤ Protect the interior of the chamber against contamination by toxic, infectious or radioactive substances. ➤ Take appropriate measures when bringing in or taking out toxic, infectious or radioactive substances.

	 DANGER
	<p>Electrical hazard by water entering the chamber.</p> <p>Deadly electric shock.</p> <ul style="list-style-type: none"> ⊘ The chamber must NOT become wet during operation, cleaning, or maintenance. ⊘ Do NOT install the chamber in damp areas or in puddles. ➤ Set up the chamber in a splash-proof manner.

The chambers were produced in accordance with VDE regulations and were routinely tested in accordance to VDE 0411-1 (IEC 61010-1).

The inner surfaces become very cold during operation.

 	 CAUTION
	<p>Danger of injury by freezing on when touching cold chamber parts during or after operation.</p> <p>Local frostbite.</p> <ul style="list-style-type: none"> ∅ Do NOT directly touch the inner surfaces or the charging material during operation. ∅ AVOID skin contact with the inner surfaces and accessory equipment. ➤ Wear protective gloves when opening the inner doors and during manipulation.

 	 WARNING
	<p>Danger of injury and damages by the chamber tipping over or breakaway of the protruding lower housing cover.</p> <p>Injuries and damage to the chamber and the charging material</p> <ul style="list-style-type: none"> ∅ Do NOT climb on the lower housing cover. ∅ Do NOT load the lower housing cover with heavy objects while the chamber door is open.

1.9 Intended use

	<p>Following the instructions in this operating manual and conducting regular maintenance work (chap. 24) are part of the intended use.</p>
---	---

Any use of the chambers that does not comply with the requirements specified in this Operating Manual shall be considered improper use.

Other applications than those described in this chapter are not approved.

Use

Ultra-low temperature freezers UF V are technical equipment and intended solely for use at work. They are suitable for safe storage of varied materials at temperatures up to $-90\text{ °C} / -130\text{ °F}$, especially for long-term storage of biological, medical, and chemical samples at constant low temperature. They are suitable for the domains Pharmacy, Medicine, Life Sciences, plastic industry, electronic components, food etc.



Freezers are designed for storage of harmless materials.

Requirements for the chamber load



The charging material shall not contain any corrosive ingredients that may damage the machine components made of stainless steel. Such ingredients include in particular acids and halides. Any corrosive damage caused by such ingredients is excluded from liability by BINDER GmbH.

None of the components of the charging material must be able to form an explosive mixture with air. Any component of the charging material must NOT be able to release toxic gases.

The chamber does not dispose of any measures of explosion protection.

 	 DANGER
	<p>Explosion or implosion hazard and danger of poisoning through the introduction of unsuitable loading material.</p> <p>Poisoning. Serious injury or death from burns and / or explosion pressure.</p> <ul style="list-style-type: none"> ∅ Do NOT introduce any substance combustible or explosive into the chamber, in particular no energy sources such as batteries or lithium-ion batteries. ∅ NO explosive dust or air-solvent mixture in the inner chamber. ∅ Do NOT introduce any substance which could lead to release of toxic gases.

Contamination of the chamber by toxic, infectious or radioactive substances must be prevented

 	 WARNING
	<p>Danger of intoxication and infection through contamination of the chamber with toxic, infectious or radioactive substances.</p> <p>Damages to health.</p> <ul style="list-style-type: none"> ➤ Protect the interior of the chamber against contamination by toxic, infectious or radioactive substances. ➤ Take appropriate measures when bringing in or taking out toxic, infectious or radioactive substances.

In case of foreseeable use of the chamber there is no risk for the user through the integration of the chamber into systems or by special environmental or operating conditions in the sense of EN 61010-1:2010. For this, the intended use of the chamber and all its connections must be observed.

Medical devices

The chambers are not classified as medical devices as defined by Regulation (EU) No 2017/745.

	<p>Due to the special demands of the Medical Device Directive (MDD), these chambers are not qualified for sterilization of medical devices as defined by the directive 93/42/EWG.</p>
---	---

Personnel Requirements

Only trained personnel with knowledge of the Operating Manual can set up and install the chamber, start it up, operate, clean, and take it out of operation. Service and repairs call for further technical requirements (e.g. electrical know-how), as well as knowledge of the service manual.

Installation site requirements

The chambers are designed for setting up inside a building (indoor use).

The requirements described in the Operating Manual for installation site and ambient conditions (Chap. 3.4) must be met.

	<p>WARNING: If customer should use a chamber running in non-supervised continuous operation, we strongly recommend in case of inclusion of irrecoverable specimen or samples to split such specimen or samples and store them in at least two chambers, if this is feasible.</p>
---	---

1.10 Foreseeable Misuse

Other applications than those described in chap. 1.9 are not approved.

This expressly includes the following misuses (the list is not exhaustive), which pose risks despite the inherently safe construction and existing technical safety equipment:

- Non-observance of Operating Manual
- Non-observance of information and warnings on the chamber (e.g. control unit messages, safety identifiers, warning signals)
- Installation, startup, operation, maintenance and repair by untrained, insufficiently qualified, or unauthorized personnel
- Missed or delayed maintenance and testing
- Non-observance of traces of wear and tear
- Insertion of materials excluded or not permitted by this Operating Manual.
- Non-compliance with the admissible parameters for processing or storing the respective material.
- Installation, testing, service or repair in the presence of solvents
- Installation of replacement parts and use of accessories and operating resources not specified and authorized by the manufacturer
- Bypassing or changing protective systems, operation of the chamber without the designated protective systems
- Non-observance of messages regarding cleaning and disinfection of the chamber.
- Spilling water or cleaning agent on the chamber, water penetrating into the chamber during operation, cleaning or maintenance.
- Cleaning activity while the chamber is turned on.
- Operation of the chamber with a damaged housing or damaged power cord
- Continued operation of the chamber during an obvious malfunction
- Insertion of objects, particularly metallic objects, in louvers or other openings or slots on the chamber
- Human error (e.g. insufficient experience, qualification, stress, exhaustion, laziness)

To prevent these and other risks from incorrect operation, it is recommended to issue operating instructions and Standard operating procedures (SOPs).

1.11 Residual Risks

The unavoidable design features of a chamber, as well as its proper field of application, can also pose risks, even during correct operation. These residual risks include hazards which, despite the inherently safe design, existing technical protective equipment, safety precautions and supplementary protective measures, cannot be ruled out.

Messages on the chamber and in the Operating Manual warn of residual risks. The consequences of these residual risks and the measures required to prevent them are listed in the Operating Manual. Moreover, the operator must take measures to minimize hazards from unavoidable residual risks. This includes, in particular, issuing operating instructions.

The following list summarizes the hazards against which this Operating Manual and the Service Manual warn, and specifies protective measures at the appropriate spots:

Unpacking, Transport, Installation

- Sliding or tilting the chamber
- Setup of the chamber in unauthorized areas
- Installation of a damaged chamber
- Installation of a chamber with damaged power cord
- Inappropriate site of installation
- Missing protective conductor connection

Normal operation

- Assembly errors
- Contact with cold surfaces on the housing and on the doors
- Emission of non-ionizing radiation from electrical operating resources
- Contact with live parts in normal state

Cleaning and Decontamination

- Penetration of water into the chamber
- Inappropriate cleaning and decontamination agents
- Enclosure of persons in the interior

Malfunction and Damage

- Continued operation of the chamber during an obvious malfunction or outage of the cooling system
- Contact with live parts during error status

Operation of a unit with damaged power cord

Maintenance

- Maintenance work on live parts.
- Execution of maintenance work by untrained/insufficiently qualified personnel
- Electrical safety analysis during annual maintenance not performed

Trouble-shooting and Repairs

- Non-observance of warning messages in the Service Manual
- Trouble-shooting of live parts without specified safety measures
- Absence of a plausibility check to rule out erroneous inscription of electrical components
- Performance of repair work by untrained/insufficiently qualified personnel
- Inappropriate repairs which do not meet the quality standard specified by BINDER
- Use of replacement parts other than BINDER original replacement parts
- Electrical safety analysis not performed after repairs

1.12 Operating instructions

Depending on the application and location of the chamber, we recommend that the operator of the chamber provides the relevant information for safe operation of the chamber in a set of operating instructions.



Keep these operating instructions with the chamber at all times in a place where they are clearly visible. They must be comprehensible and written in the language of the employees.

1.13 Measures to prevent accidents

The operator of the chamber must observe the locally applicable regulations for operating the chamber (for Germany: Occupational Safety Regulations. Operation of refrigeration chambers, heat pumps and cooling systems, GUV-R 500 chap. 2.35) and take precautions to prevent accidents.

Following measures have been taken by the manufacturer in order to prevent ignition and explosions:

- **Indications of the type plate**

See operating manual chap. 1.6

- **Operating manual**

An operating manual is available for each chamber.

- **Temperature monitoring**

The chamber has a temperature display which can be read from outside.

An additional temperature safety device is built into the chamber. A visual and an audible signal (buzzer) show exceeding of the temperature.

- **Safety, measurement and control devices**

The safety, measuring, and control devices are easily accessible.

- **Electrostatic charge**

The interior parts are grounded.

- **Non-ionizing radiation**

Non-ionizing radiation is not intentionally produced, but released only for technical reasons by electrical equipment (e.g. electric motors). The machine has strong permanent magnets. If persons with active implants (e.g. pacemakers, defibrillators) keep a safe distance (distance of field source to implant) of 30 cm, an influence of these implants can be excluded with high probability.

- **Protection against touchable surfaces**

Tested according to EN ISO 13732-3:2008.

- **Floors**

See operating manual chap. 3.4 for installation

- **Cleaning**

See operating manual chap. 24.

- **Examinations**

The chamber has been inspected by the "VDE Prüf- und Zertifizierungsinstitut" (Testing and Certification Institute of the Association for Electrical, Electronic and Information Technologies) and bears the GS mark. Not valid for UL chambers. Not valid for UF V 350. Not valid for chambers equipped with the optional CO₂ emergency cooling.

UL chambers only: The chamber is certified by Underwriters Laboratories Inc.® according to the standards UL 61010-1, 3rd Edition, 2012-05, Rev. 2016-04; UL 61010-2-011, 1st Edition, 2017-01; CAN/CSA-C22.2 No. 61010-1, 3rd Edition, 2012-05, Rev. 2016-04. Not valid for UF V 350. Not valid for chambers equipped with the optional CO₂ emergency cooling.

2. Chamber description

The ultra-low temperature freezers UF V were produced with great care using the latest tools for development and production. They were optimized for safe long-term storage of samples in the ultra-low temperature range. You can operate the freezer in a temperature range from $-90\text{ °C} / -130\text{ °F}$ up to $-40\text{ °C} / -40\text{ °F}$.

The freezers are available with the advanced voltage booster AVC option.

The freezers are available for several different voltages.

Door access system (option for UF V 500 and UF V 700):

The freezers are optionally available with an electromechanical door locking and electronic access control via NumPad, permitting personalized access control.

A pushbutton permits opening the electromechanical door locking without using your hands. A pull-tight function automatically closes the outer door when slightly open.

Lockable protective flap for the main power switch (option)

An additional locking system with key for the freezer's main power switch is optionally available.

Controller

The efficient RD4 chamber controller is equipped with a multitude of operating functions, in addition to recorder and alarm functions. Set-point entry is easily accomplished directly via the chamber controller and is also possible directly with a computer via Intranet in connection with the APT-COM™ 4 Multi Management Software (option, chap. 22.2).

Temperature setting is accurate to a tenth of a degree. The controller is mounted at the optimal height for operation.

The controller offers an error diagnostics system generating audible and visual warning and alarm messages.

Chambers with the option "battery-buffered alarm system": During power failure, alarm function and control remain active during 72h. The controller provides password protection for the setting menus.

The controller monitors ambient temperature and issues an alarm if it exceeds an adjustable value.

Housing

The inner chamber and the inside of the insulated outer door are made of stainless steel (German material no. 1.4016, US equivalent AISI 430). The housing including all corners and edges is RAL 7035 varnished. The inner surfaces are smooth and therefore easy to clean. Easy front access permits filter cleaning without tools. Two 28 mm access port serve to introduce a sensor cable of a measuring device, the upper one also to connect the optional CO₂ emergency cooling.

The buildup of ice in the door area is minimal due to perfect closing of the inner and outer doors. Precise spatial distribution of the cold in the interior ensures storage of all samples at an identical storage temperature. The prevention of thermal bridges protects against defrosting. The combination of vacuum insulation panels (V technology) and CFC-free polyurethane foaming maximizes the cold storage capacity.

The freezer has two compartment doors. You can insert stainless steel shelves and make optimum use of the interior. You can flexibly arrange the shelves to use the interior in a variable and optimum manner. Inventory racks (stainless steel storage racks with cryo boxes, chap. 23) are optionally available.

Castors with locks serve to move the freezer.

Cooling system

The powerful, energy-efficient and low-noise refrigerating machine uses the environmentally friendly "green" refrigerants R290 (propane) und R170 (ethane). They are completely free of HCFCs (hydrochloro-fluorocarbons) and CFCs (chlorofluorocarbon).

Control of the two-stage refrigerating machine: The 1st stage cooling immediately turns on. In addition, the 2nd stage cooling turns on depending on the temperature.

Safety

Thanks to the standard overtemperature safety device, the set temperature is maintained also in case of a controller failure.

In case of power failure at -80 °C / -112 °F, a temperature of -60 °C / -76 °F will not be exceeded in an empty freezer for at least 3.5 hours, in a loaded freezer (measured with a 30 kg / 66 lb water load) for approx. 7 hours.

Battery-buffered alarm system (option)

The freezer is optionally equipped with a rechargeable battery (12 V, 7.2 Ah). Battery voltage is regularly monitored. An alarm indicates too low battery voltage. You can check the battery voltage in the controller menu.

The advanced voltage booster optionally available provides automatic voltage compensation through a buck/boost converter (chap. 4.6).

An error diagnostics system monitors the chamber functions and generates audible and visual warning and alarm messages. E.g., the door is monitored for being closed.

The CO₂ emergency cooling (option, chap. 21) offers additional refrigeration, i.e., following introduction of a heat load, in case of a power failure or failure of the cooling system.

Data monitoring and recording

The chamber is regularly equipped with a zero-voltage relay alarm output (chap. 14.4.7) and optionally with an analog output (chap. 22.3) for integration into customer systems.

The freezer is regularly equipped with an Ethernet interface (chap. 22.1) for computer communication, enabling monitoring via a network. The BINDER APT-COM™ 4 Multi Management Software (option, chap. 22.2) permits networking of up to 40 chambers and connection to a computer, as well as recording and representing temperature data. Data are given out in compliance with FDA guideline 21 CFR part 11.

2.1 Chamber overview

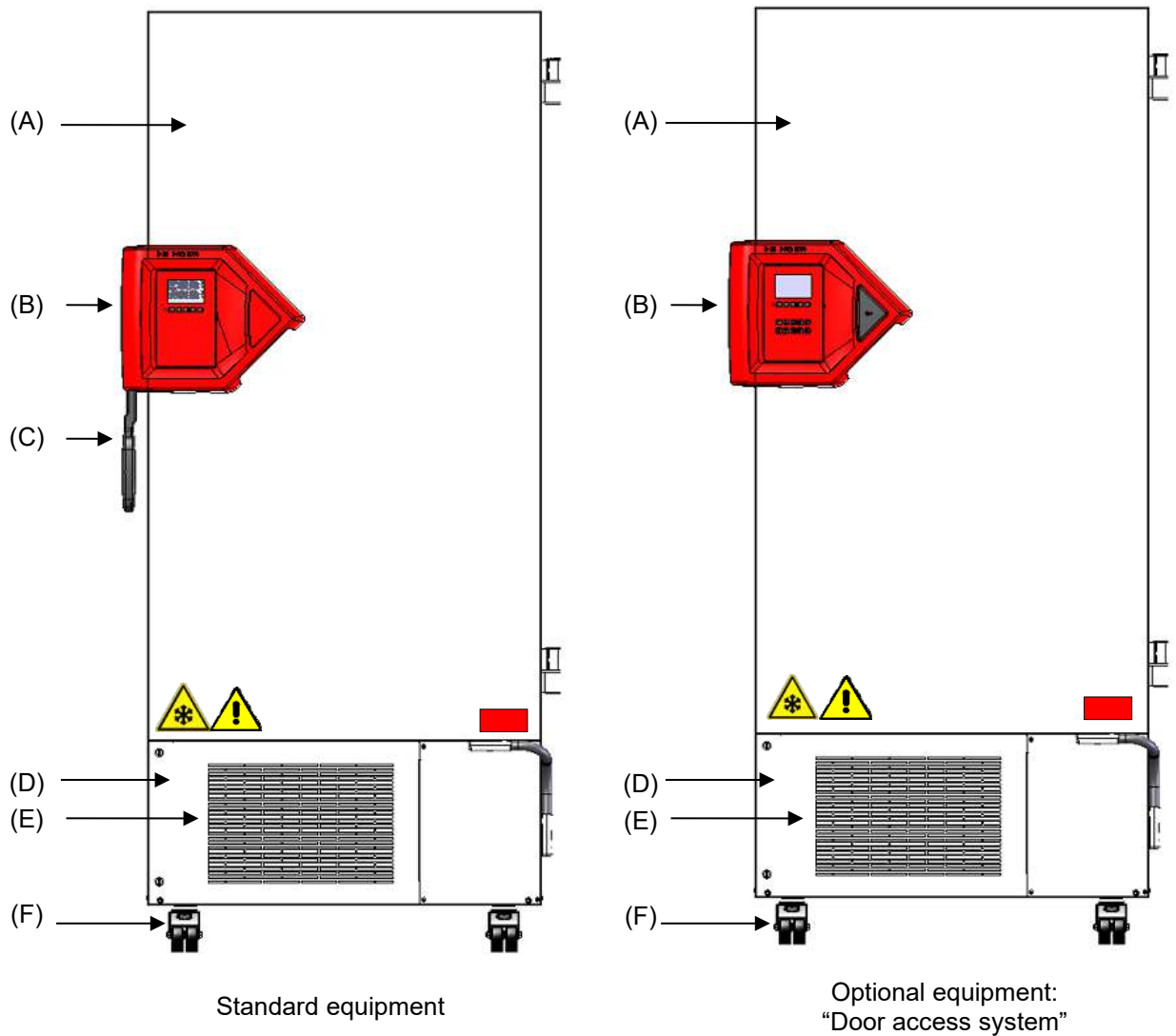

Figure 5: Ultra-low temperature freezer UF V (example UF V 700), front view

- (A) Outer door
- (B) Door lock and controller housing (description chap. 2.2)
- (C) Door handle
- (D) Compressor housing
- (E) Air filter flap (checking and cleaning / replacing the filter chap. 25.2.1)
- (F) Castors (front castors lockable by breaks)



Figure 6: Ultra-low temperature freezer UF V 700, open

- (A) Outer door
- (B) Door lock and controller housing (description chap. 2.2)
- (C) Door handle
- (D) Compressor housing
- (E) Air filter flap (checking and cleaning / replacing the filter chap. 25.2.1)
- (F) Castors (front castors lockable by breaks)
- (G) Compartment with variable shelf
- (H) Compartment door
- (I) Pressure compensation valve (inside of the door behind the door lock and controller housing)

2.2 Door lock and controller housing

The controller operator panel is integrated in the freezer's door lock and controller housing (B).
With the standard chamber a door handle (C) serves to open and close the chamber door.

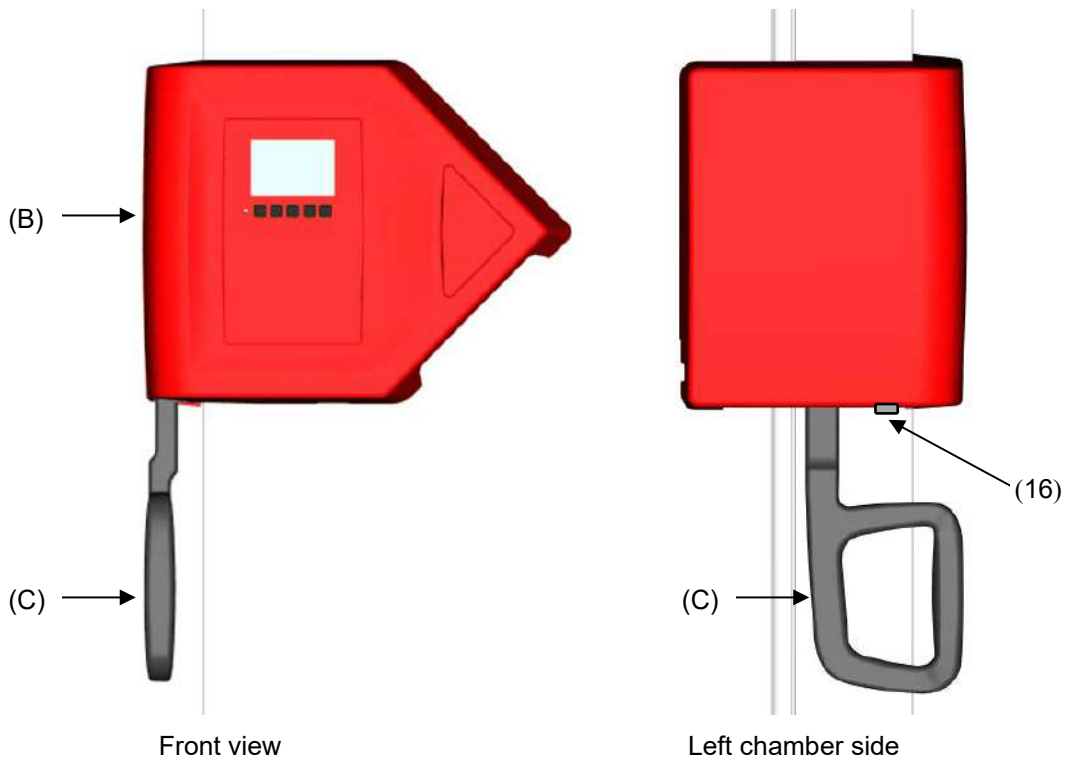

Figure 7: Standard chamber: Door lock and controller housing with controller operator panel and door handle

- (B) Door lock and controller housing
- (C) Door handle
- (16) Door lock (optional)

Chambers with the "Door access system" option (option for UF V 500 and UF V 700) are equipped with an electromechanical door locking and electronic access control via NumPad.

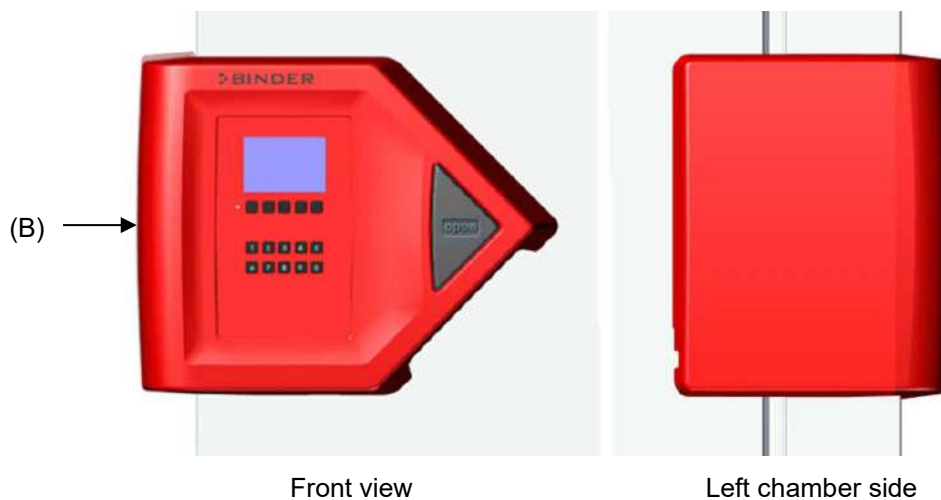

Figure 8: Chamber with "Door access system" option: Door lock and controller housing with Numpad, controller operator panel and pushbutton "OPEN" to open the door

2.2.1 Operating the NumPad (option “Door access system” for UF V 500 and UF V 700)

Combined with the electromechanical door locking the NumPad permits personalized access control to the freezer.

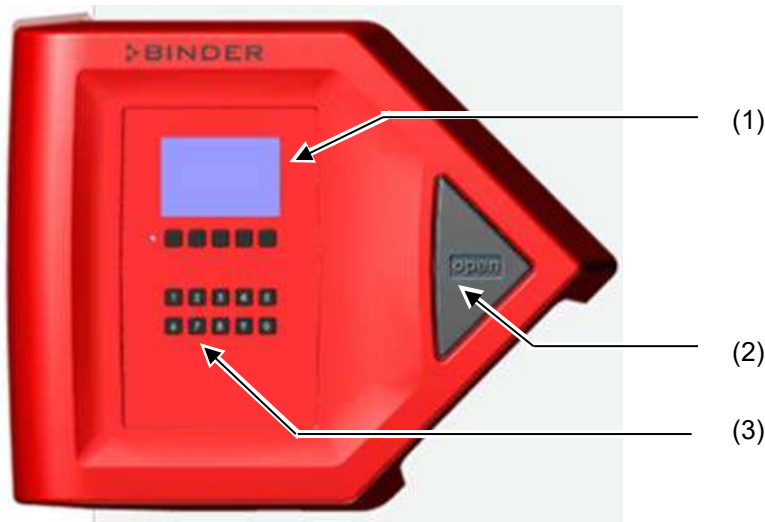

Figure 9: Door lock and controller housing with “Door access system” option: Numpad, controller operating panel and pushbutton “OPEN” to open the chamber door

- (1) Controller RD4 operating panel
- (2) Pushbutton “OPEN” to open the chamber door
- (3) NumPad to control the electromechanical door locking

2.2.2 Operating the electromechanical door locking (option “Door access system” for UF V 500 and UF V 700)

A pushbutton permits opening the electromechanical door locking without using your hands. A pull-tight function automatically closes the outer door when slightly open.

Opening the door:



Firmly press the one-touch pushbutton “OPEN”. You can now open the door.

Closing the door:

Firmly press on the door for at least 2 seconds until the automatic door mechanism is activated and closes the door tightly.



Figure 10: Pushbutton “OPEN” to open the door

 	 DANGER
<p>Risk of locking in a person. Death from suffocation or freezing.</p> <ul style="list-style-type: none"> ➤ Before closing doors, make sure that nobody is inside. ➤ Pull the power plug before entering the interior (e.g. for cleaning purposes). 	

2.3 Main power switch

The main power switch is located on the bottom right side of the chamber.

In addition, a lockable protective flap covering the main power switch is optionally available. It can be unlocked with a key and then removed.

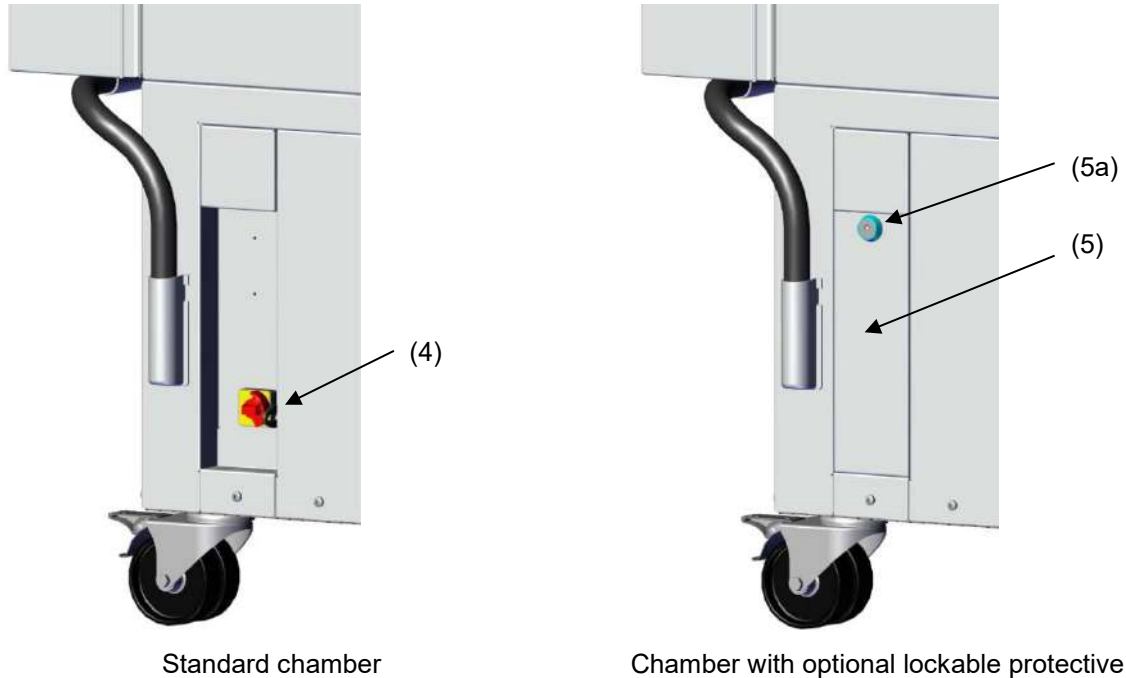

Figure 11: Position of the main power switch and the lockable protective flap (option) on the right side of the chamber

- (4) Main power switch
- (5) Lockable protective flap (option)
- (5a) Key lock of the optional lockable protective flap



Figure 12: Main power switch (4) on the right side of the chamber

2.4 Chamber rear

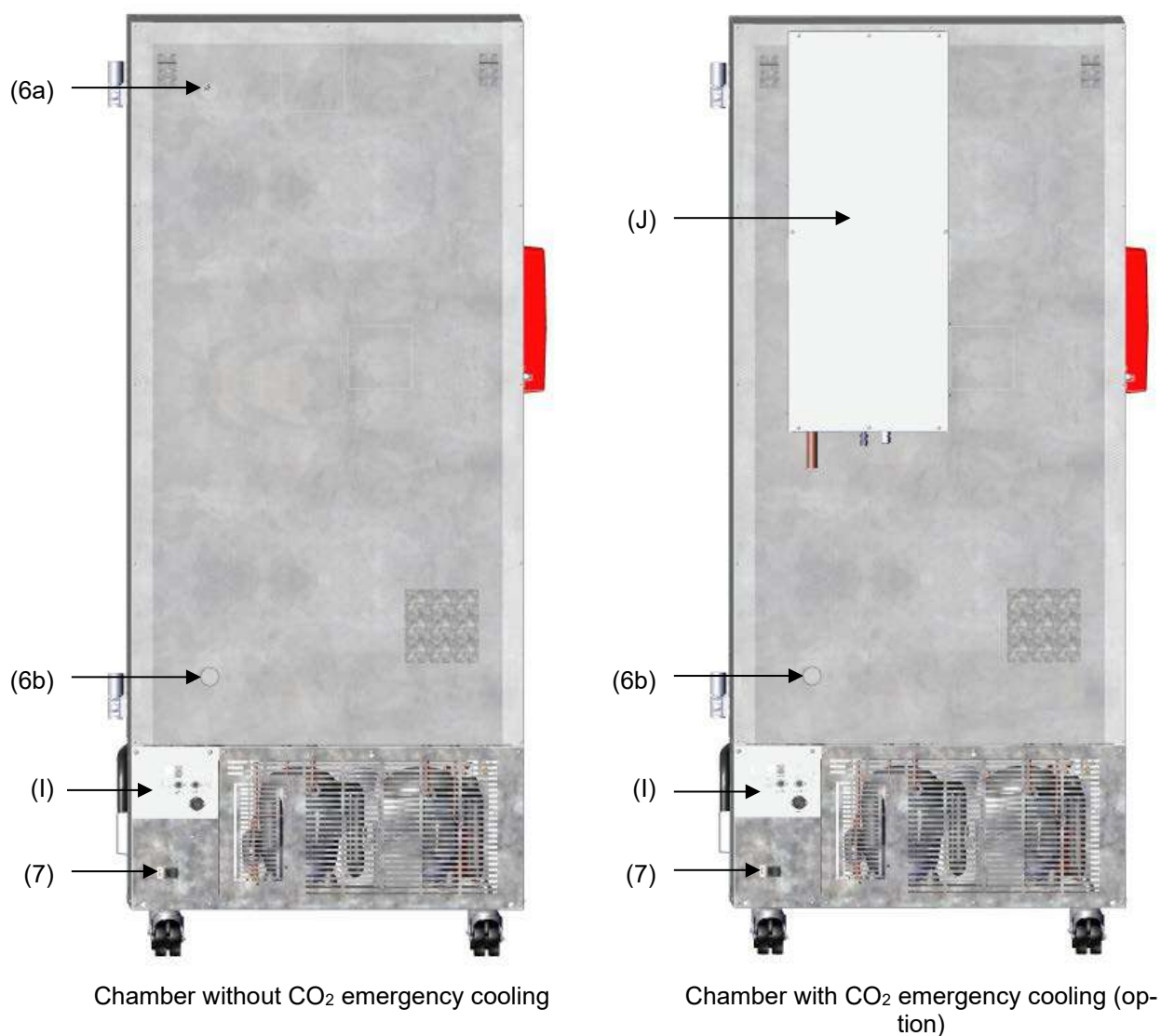

Figure 13: Chamber rear

- (6a) 28 mm access port to connect the der CO₂ emergency cooling (option) or for cable of a supplementary measuring device
- (6b) 28 mm access port, e.g., for cable of a supplementary measuring device
- (7) Connecting socket for IEC connector plug with strain relief
- (l) Connection panel
- (J) CO₂ emergency cooling (option, chap. 21)

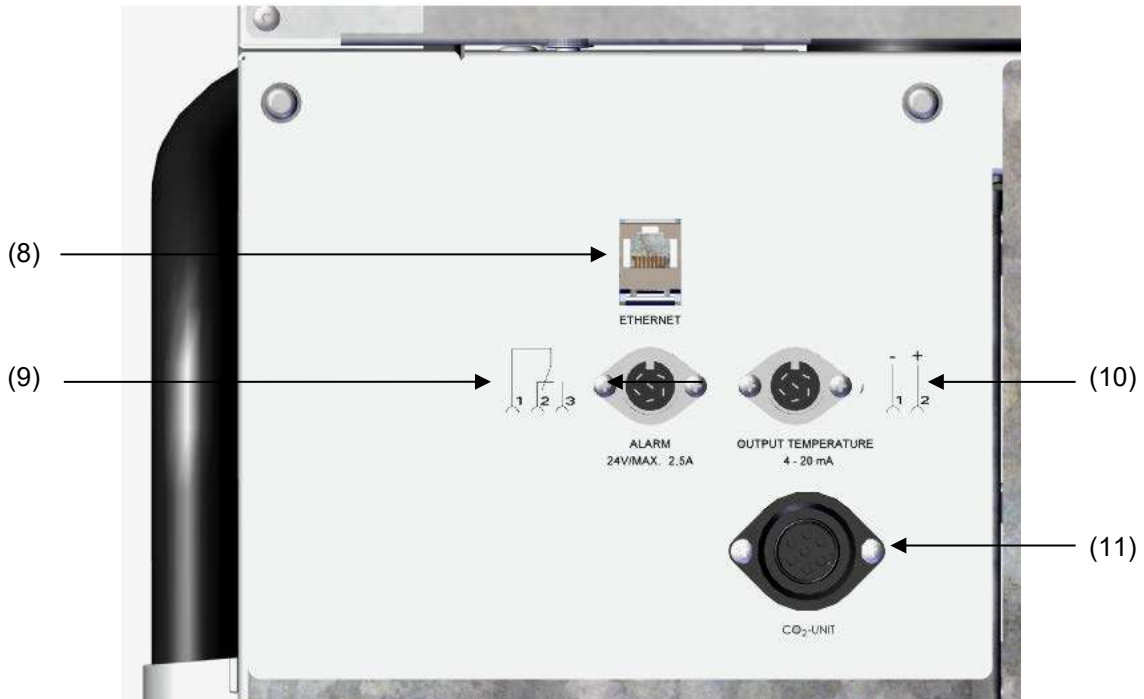

Figure 14: Connection panel (I) on the chamber rear, with options

- (8) Ethernet interface (Chap. 22.1)
- (9) Connection socket for zero-voltage relay alarm contact (chap. 14.5)
- (10) Connection socket for analog output 4-20 mA (option, chap. 22.3)
- (11) Connection socket for the electrical connection of the CO₂ emergency cooling (option, chap. 21)

2.5 Doors

2.5.1 Outer door

The outer door must be closed while the chamber is operating normally in order to ensure stable conditions in the inner chamber.



Delay time for the door open alarm:

After closing the outer door, the door open alarm is switched off for a programmable delay time (factory setting: 1 minute).

2.5.2 Compartment doors

The freezer interior is divided into 4 compartments, which are isolated against the surrounding with two doors. That permits bringing in or removing the samples of an individual compartment without remarkably affect temperature in the other compartments.

The compartment doors remain closed by magnetism when opening the outer door without need for closing them mechanically.

Open the inner doors as shortly as possible to avoid a temperature rise inside the freezer. The maximum angle of aperture is 100°.

For the additional thermal insulation and sealing of the interior compartment doors, you can order the option "compartment doors, insulated". For this purpose, the compartment doors are filled with foam and thus additionally thermally insulated.

2.5.3 Operating the door lock (option “Lockable door handle”)

Chambers with this option are equipped with a door lock (16), which is located on the left side of the chamber in front of the door handle. Two keys are included. To lock the door lock, turn the key clockwise. The key can be removed in both positions (open / locked).

Note: Be sure to remove the key before opening the door. Otherwise the door lock may be damaged.

	NOTICE
	<p>Danger of damage when opening the door with the key inserted. Damage to the door lock.</p> <p>➤ Remove the key before opening the door with the door handle.</p>

2.6 Drain well for condensate during defrosting (option)

The drain well collects the dripping water when defrosting.

Strong magnets on the drain well sides fix it on the chamber.

Attach the drain well to the freezer. Its first level rests on the lower housing panel. The gasket is aligned to the bottom edge of the freezer interior.



Figure 15: Freezer with drain well (option)

While defrosting use adhesive tape to keep the door above the drain well (drain off position). Now the melted condensate flows into the drain well.



Place a reservoir below the hole at the front left corner of the drain well, so that the water can drain off.

3. Completeness of delivery, transportation, storage, and installation

3.1 Unpacking, and checking equipment and completeness of delivery

After unpacking, please check the chamber and its optional accessories, if any, based on the delivery receipt for completeness and for transportation damage. Inform the carrier immediately if transportation damage has occurred.

Caution: The drain well is placed under the chamber between the castors. Please remove it before unpacking the freezer!

	 CAUTION
	<p>Risk of injury and damages by sliding or tilting of the chamber due to improper lifting.</p> <p>Injuries, damage to the chamber.</p> <ul style="list-style-type: none"> ⊘ Do NOT lift the chamber using the door, the door lock and controller housing or the lower housing. ⊘ Do NOT lift the chamber by hand. ⊘ If possible, avoid transporting the chamber horizontally. It may be transported lying down ONLY on the hinge side or on its back, but must then stand upright for at least 24 hours before turning on. ⊘ ➤ Lift the chamber using technical devices (fork lifter) from the pallet. Set the fork lifter laterally or from the rear in the middle of the chamber. Make sure to place all the lateral supports of the chamber on the forks (check: the fork protrudes at the opposite chamber side). ➤ Wear suitable shoes (safety shoes).

The final tests of the manufacturer may cause traces of the shelves on the inner surfaces. This has no impact on the function and performance of the chamber.

Please remove any transportation protection devices and adhesives in/on the chamber and on the doors and remove the operating manuals and accessory equipment.

	<p>Remove any protective lamination sheet on the inner metal surfaces prior to commissioning.</p>
---	---

	<p>Wait at least 8 hours following transport with technical devices (chap. 3.2.2) before start-up.</p>
---	--

If you need to return the chamber, please use the original packing and observe the guidelines for safe lifting and transportation (chap. 3.2).

For disposal of the transport packing, see chap. 26.1.

Scope of delivery

- Ultra-low temperature freezer UF V
- 3 shelves and 12 shelf holders with 6 screws
- DIN plug for the zero-voltage relay alarm output (connected)
- Set of 2 spacers for rear wall distance.
- Operating manual (set)
- Water connection sets with chambers with water cooling

Note on second-hand chambers (Ex-Demo-Units)

Second-hand chambers are chambers that have been used for a short time for tests or exhibitions. They are thoroughly tested before resale. BINDER ensures that the chamber is technically sound and will work flawlessly.

Second-hand chambers are marked with a sticker on the chamber door. Please remove the sticker before commissioning the chamber.

3.2 Guidelines for safe lifting and transportation

3.2.1 Moving the freezer inside a building

Before moving the freezer unlock the front castors. The castors are designed only for moving the freezer inside a building. This is possible only on a floor without joints (e.g. no tiles) and when avoiding shocks. In this case, the freezer must not be empty (max. load, see technical data, chap. 27.3).

If you want to move the chamber across a large door threshold or into an elevator to change the floor, empty the freezer and put all shelves on the bottom of the interior.

If you incline the chamber by less than 5°, you can directly turn it on after moving (at least 10 minutes after turning off). Otherwise, wait at least 8 hours until putting it into operation again.

As soon as the chamber has reached its destination, lock the front castors.



Wear suitable shoes (safety shoes) when moving the freezer.

Over very short distances (within reach of the power cable), you can move the freezer while operating.

If you turned off the chamber (turning off at the main power switch, pulling the power plug), wait at least 10 minutes after moving until you turn on again the chamber in order to protect the refrigeration machine against damage.



NOTICE

Risk of damage to the refrigeration system due to too quick restart of the refrigeration machine after moving the chamber.

Damage to the chamber.

- After moving the freezer wait 10 minutes before turning on the freezer again.

To move the freezer through narrow passages (doors, narrow corridors), open the chamber door:

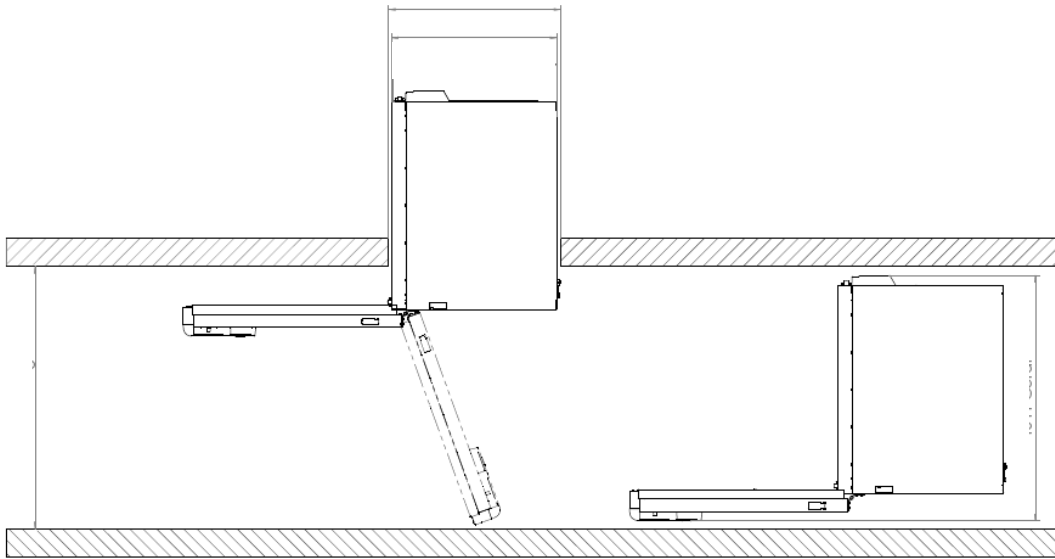





Figure 16: UF V with open chamber door

For transport outside a building use technical equipment (chap. 3.2.2).

3.2.2 Transport outside a building

Before moving the chamber unlock the front castors. The castors are designed only for moving the chamber inside a building (respect the information given in chap. 3.2.1).

After operation, please observe the guidelines for temporarily decommissioning the chamber (chap. 26.2).

 	 CAUTION
	<p>Risk of injury and damages by sliding or tilting of the chamber due to improper transportation.</p> <p>Injuries, damage to the chamber.</p> <ul style="list-style-type: none"> ⊘ Do NOT lift or transport the chamber using the door, the door lock and controller housing or the lower housing. ⊘ Do NOT lift the chamber by hand ⊘ If possible, avoid transporting the chamber horizontally. It may be transported lying down ONLY on the hinge side or on its back, but must then stand upright for at least 24 hours before turning on. ➤ Transport the chamber only in its original packaging. ➤ Secure the chamber with transport straps for transport. ➤ Place the shelves on top of each other on the bottom of the interior. ➤ Lift the chamber using technical devices (fork lifter) and place it on the transport pallet. Set the fork lifter laterally or from the rear in the middle of the chamber. Make sure to place all the lateral supports of the chamber on the forks (check: the fork protrudes at the opposite chamber side). ➤ Transport chambers ONLY with the original transport pallet. Set the fork lifter only to the pallet. Without the pallet the chamber is in imminent danger of overturning ➤ Wear suitable shoes (safety shoes).

- Permissible ambient temperature range for transport: $-10\text{ °C} / 14\text{ °F}$ to $+60\text{ °C} / 140\text{ °F}$.

You can order transport packing and rolling pallets for transportation purposes from BINDER Service.

	Wear suitable shoes (safety shoes) during transport.
---	--

	Following transport, wait at least 8 hours until start-up.
---	--

3.3 Storage

Intermediate storage of the chamber is possible in a closed and dry room. Observe the guidelines for temporary decommissioning (chap. 26.2).

- Permissible ambient temperature range for storage: $-10\text{ °C} / 14\text{ °F}$ to $+60\text{ °C} / 140\text{ °F}$.
- Permissible ambient humidity: max. 70% r.h., non-condensing

Secure the chamber against unintentional rolling by locking the front castors.

The freezer must stand upright in order to avoid oil running out of the engine casing and resulting damages to the cooling system. Max. angle of inclination: 10° .

When after storage in a cold location you transfer the chamber to its warmer installation site, condensation may form in the inner chamber or on the housing. Before start-up, wait at least one hour until the freezer has attained ambient temperature and is completely dry. According to the type of transport that has taken place (chap. 3.2) you may have to wait at least 8 hours until start up.

3.4 Location of installation and ambient conditions

The freezer is designed for setting up inside a building (indoor use). Set up the chamber on a flat, even surface, free from vibration and in a well-ventilated, dry location. Lock the front castors and align the chamber using a spirit level. The site of installation must be capable of supporting the chamber's weight (see technical data, chap. 27.3).

	NOTICE
	<p>Danger of overheating due to lack of ventilation. Damage to the chamber.</p> <ul style="list-style-type: none"> ⊘ Do NOT install the chamber in unventilated recesses. ➤ Ensure sufficient ventilation for dispersal of the heat. ➤ Make sure that all ventilation openings are uncovered. ➤ Observe the prescribed minimum distances when installing the chamber.

	NOTICE
	<p>Danger to the environment by leakage of refrigerant in the event of a chamber defect. Alteration of the environment.</p> <ul style="list-style-type: none"> ➤ Ensure sufficient ventilation of the installation site.

- Permissible ambient temperature range for operation: $+18\text{ °C} / 64.4\text{ °F}$ to $+32\text{ °C} / 89.6\text{ °F}$. At elevated ambient temperature values, fluctuations in temperature can occur.

	The ambient temperature should not be substantially higher than the indicated ambient temperature of $+22 \pm 3\text{ °C} / 71.6\text{ °F} \pm 5.4\text{ °F}$ to which the specified technical data relate. For other ambient conditions, deviations from the indicated data are possible.
---	--

Prevent the freezer from sucking warm air from other devices.



Avoid direct solar radiation on the chamber. Do not place the freezer in direct vicinity of chambers with a high heat emission.

- Permissible ambient humidity: 70% r.h. max., non-condensing.
- Installation height: max. 2000 m / 6561.7 ft above sea level.

Minimum distances:

- between several chambers: 250 mm / 9.84 in
- Wall distance, rear: 100 mm / 3.94 in (spacer is supplied, see chap. 4.2)
- Wall distance, laterally, on the side without door hinge: 100 mm / 3.94 in
- Wall distance, laterally, on the side with door hinge: 240 mm / 9.45 in.
- Spacing above the chamber: 100 mm / 3.94 in

Ventilation openings must not be blocked. Ensure a distance of at least 100 mm / 3.94 in to the ventilation openings on the freezer's front and rear.



To completely separate the chamber from the power supply, you must disconnect the power plug. Install the chamber in a way that the power plug is easily accessible and can be easily pulled in case of danger.

With an increased amount of dust in the ambient air, clean the condenser fan (by suction or blowing) several times a year. Check the condenser air filter frequently and clean it if necessary (chap. 25.2.1).

Avoid any conductive dust in the ambiance according to the chamber layout complying with pollution degree 2 (IEC 61010-1).

For the user there is no risk of temporary overvoltages in the sense of EN 61010-1:2010.

Do NOT install or operate the freezer in potentially explosive areas.



DANGER

Danger of explosion due to combustible dusts or explosive mixtures in the vicinity of the chamber.

Serious injury or death from burns and / or explosion pressure.

- ⊘ Do NOT operate the chamber in potentially explosive areas.
- KEEP combustible dust or air-solvent mixtures AWAY from the chamber.

For freezers with water cooling:



To avoid any possible water damage, provide a floor drain at the location of the device. Select a suitable installation site to avoid any consequential damage by splashing water.

4. Installation and connections

4.1 Operating instructions

Depending on the application and location of the chamber, we recommend that the operator of the freezer provides the relevant information for safe operation of the chamber in a set of operating instructions.



Keep these operating instructions with the chamber at all times in a place where they are clearly visible. They must be comprehensible and written in the language of the employees.

4.2 Spacers for rear wall distance

Please fix both spacers with the supplied screws at the chamber rear. This serves to ensure the prescribed minimum distance to the rear wall of 100 mm / 3.94 in.

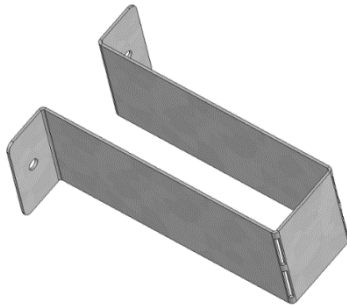

Figure 17: Spacer for rear wall distance

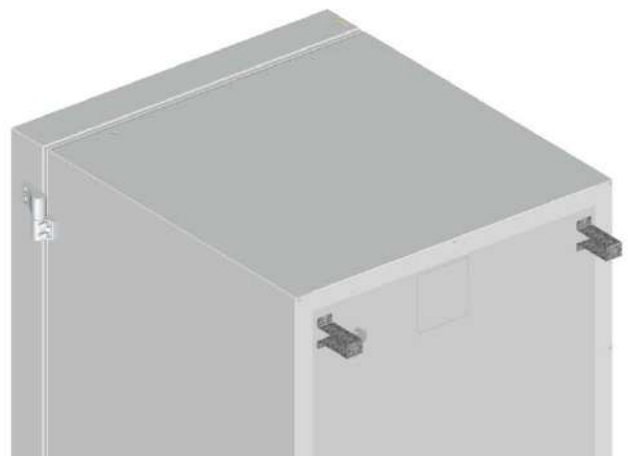

Figure 18: Rear UF V 700 with mounted spacers

4.3 Support feet (UF V 350 only)

To prevent tipping, it is necessary to extend the support feet on the front side under the door after the device has been set up

4.4 Adjustable shelves

The scope of delivery comprises three adjustable shelves. You can mount them and further optional shelves in different positions of the lateral walls in 24 mm / 1 inch steps. In standard position, the shelves are placed with a distance of 310mm / 12.2 in, forming the bottom of the compartments, thus making available the maximum space for optional inventory systems.

It is required to fix the adjustable shelves in order to avoid that a person could be locked in the freezer. To remove a shelf, remove the screws, lift and incline the shelf and then pull it forward

Mounting the adjustable shelves:

- Insert the shelf holders at the desired height into shelf holder bars.
- Insert the shelves and screw them with a Phillips screwdriver to the shelf holders



Figure 19: Inserting the shelf holders

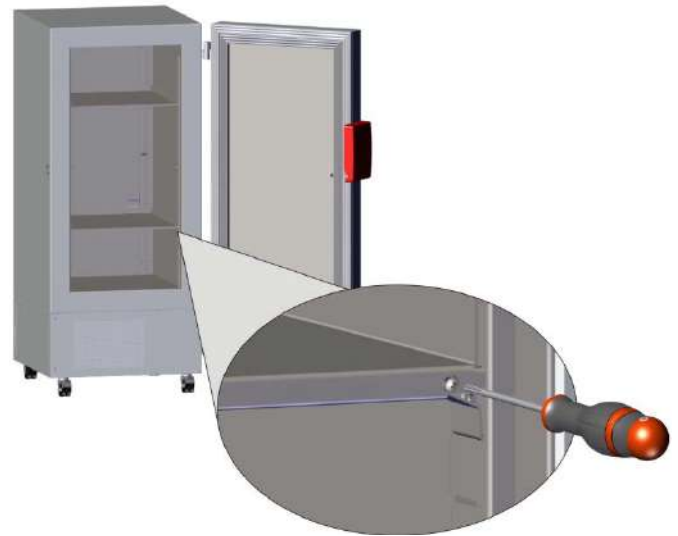
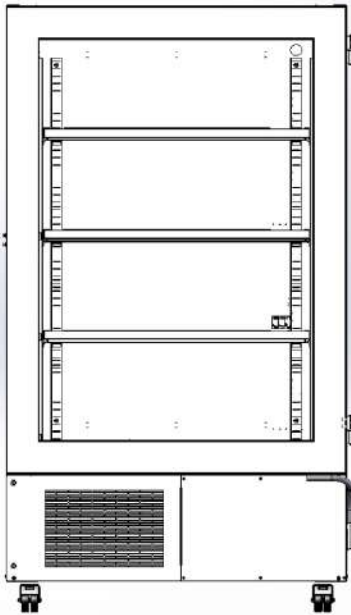
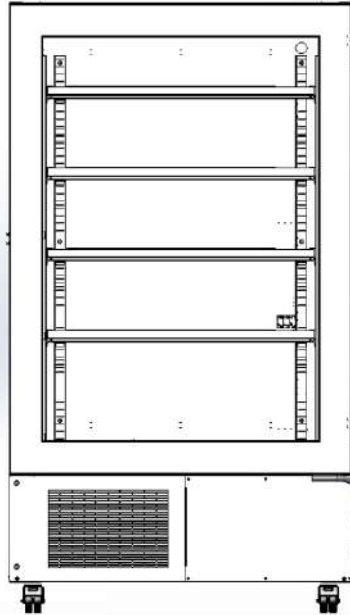
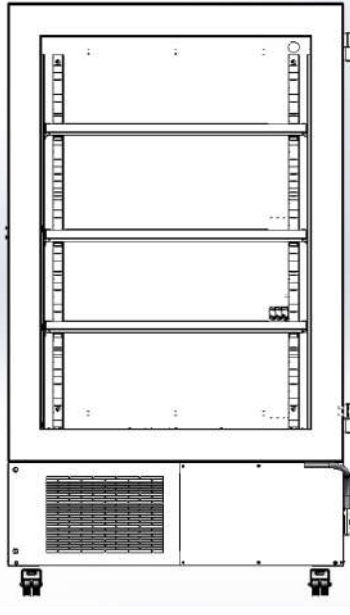
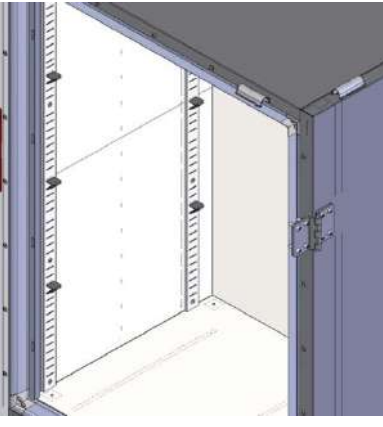
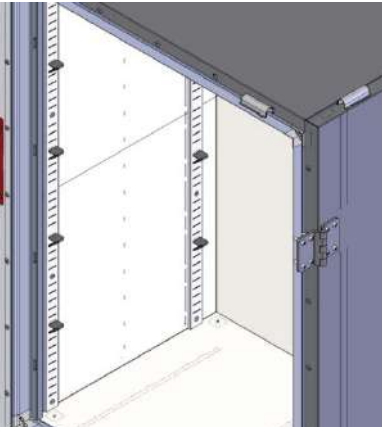
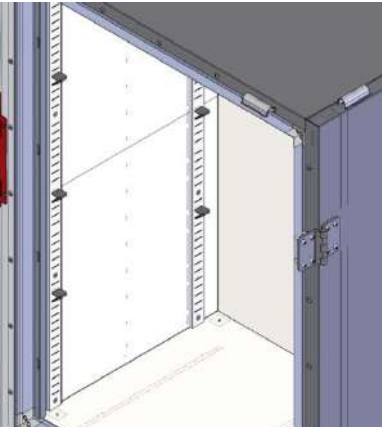

Figure 20: Screwing the shelves to the shelf holders

For optimal use of space, we recommend the following shelf positions:

Position of 3 shelves to obtain 4 compartments with equal ceiling height	Position of 4 shelves (1 x optional) to obtain 5 compartments with equal ceiling height	Position of 3 shelves to obtain the maximum sample storage space: 2 compartments with a ceiling height of 334 mm / 13.15 in (for racks 4x6) and 2 compartments with a ceiling height of 279 mm / 11 in (for racks 4x5)
		
		
<p>Insert the shelf holders into the following positions of the shelf holder bar (starting from the bottom): 18, 35, 53</p>	<p>Insert the shelf holders into the following positions of the shelf holder bar (starting from the bottom): 13, 29, 42, 58</p>	<p>Insert the shelf holders into the following positions of the shelf holder bar (starting from the bottom): 21, 36, 53</p>

Permitted shelf loads:

Chamber size		350	500	700
Permitted load of individual shelf (regular)	kg / lbs	40 kg	50 / 110	50 / 110
Permitted total load of all shelves (regular)	kg / lbs	160 kg	200 / 441	200 / 441

If the upper shelf is loaded with maximum load, a minimum distance of 24 cm / 9.4 in to the ceiling of the interior must be observed. Therefore, do not insert the shelf above position 59 (counted from bottom) of the shelf holder bar.

4.5 Connections of cooling water for chambers with water cooling

The water cooling reduces the heat, which is emitted during cooling operation to the ambient air. An enclosure inside the chamber contains the connection kit for the cooling water inlet and outlet.

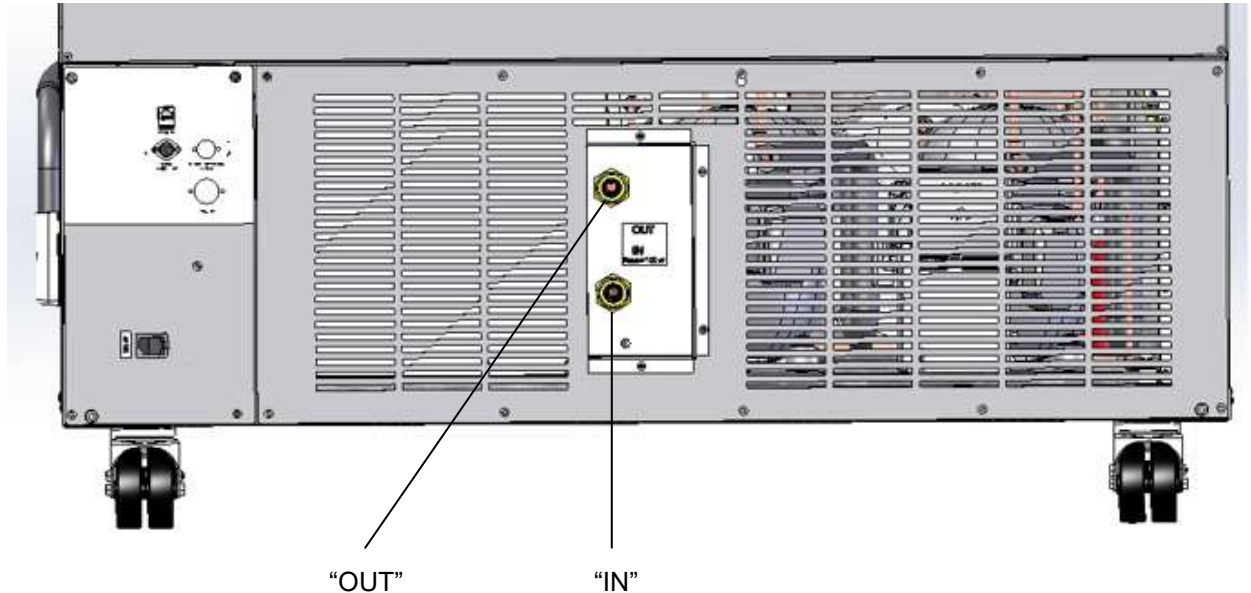

Figure 21: Connections of cooling water on the chamber rear (chambers with water cooling), example UF V 700

“IN” connection for cooling water inlet with external thread $\frac{3}{4}$ ” and internal thread $\frac{3}{8}$ ”

“OUT” connection for cooling water outlet with external thread $\frac{3}{4}$ ” and internal thread $\frac{3}{8}$ ”

4.5.1 Connection of cooling water outlet for water cooling

Fasten the $\frac{1}{2}$ ” cooling hose to the connection of cooling water outlet “OUT” on the chamber rear. Observe the following points:

- You can use a part of the supplied water hose for the cooling water outlet. In case another hose is used, it must be permanently resistant against max. 50 °C / 122 °F and pressure-resistant up to 10 bar.
- Put the hose on the hose nozzle with screwing and secure it with one of the four supplied hose clamps. Connect the hose nozzle to the connection “OUT” and screw on the union nut.
- For the hose connection to the domestic water connection, we recommend to also use the supplied hose nozzle with screwing and secure it with one of the four supplied hose clamps.
- Before turning on the chamber, check the connection for leaks.

The temperature of the effluent cooling water is 27 °C up to 29 °C on account of the chamber’s construction.

4.5.2 Connection of cooling water inlet for water cooling



Connect the cooling water outlet **before** connecting the cooling water inlet.

Requirements for the cooling water:

- Water type: cooling water, air conditioning water, tap water
- Water intake temperature: 8 °C / 46.4 °F up to 23 °C / 73.4 °F
- pH value 4 up to 8
- Water hardness of max. 142.8 mg/l (ppm) = 10 English (Clark) degrees = 8.32° grains per U.S. gallon = 1.4285 mmol/l.
- Particle size < 100 µm
- Connection pressure 1 bar up to 10 bar overpressure
- Pressure difference between inlet and outlet: at least 0,2 bar; 0,5 bar recommended. A higher pressure difference can result in flow noise.
- The water inlet and outlet should be provided with a shut-off slide or water-tap.

Water demand:

- Average 10-50 l/h, depending on the intake temperature
- Short-term (duration up to 2 minutes) up to 400 l/h



BINDER GmbH is NOT responsible for the water quality at the user's site.
Any problems and malfunctions that might arise following use of water of deviating quality is excluded from liability by BINDER GmbH. This includes in particular a high particle content, which may result in blockage of the water flow control valve.
The warranty becomes void in the event of use of water of deviating quality.

Fasten the 1/2" cooling hose to the connection of cooling water outlet "IN" on the chamber rear. Observe the following points:

- You can use a part of the supplied water hose for the cooling water inlet. In case another hose is used, it must be pressure-resistant up to 10 bar.
- Put the hose on the hose nozzle with screwing and secure it with one of the four supplied hose clamps. Connect the hose nozzle to the connection "IN" and screw on the union nut.
- For the hose connection to the domestic water connection, we recommend to also use the supplied hose nozzle with screwing and secure it with one of the four supplied hose clamps.
- Before turning on the chamber, check the connection for leaks.

Water is supplied automatically via the "IN" water connection.

4.5.3 Connection kit for cooling water

The ultra-low temperature freezer with water cooling comes with a connection kit. It consists of the following:

- Hose burst protection device
- 4 Hose nozzles with screwing (union nut)
- 4 hose clamps
- 6m water hose 1/2", divisible for inlet and outlet, approved for max. 15 bar, max. 95 °C

Protection principle of the hose burst protection

The hose burst protection device serves to protect the environment against flooding caused by burst water hoses. It is intended for the operation of the device at a tap water line. If the freezer is operated in a cycle of cooling water or air conditioning water, the user should check whether the hose burst protection device provides sufficient protection. This depends mainly on a sufficient medium pressure in the system.

Whenever a strong water flow of approx. 18 l / min. occurs, e.g. caused by a burst water hose, a valve automatically cuts off the water supply, which can be heard as a clicking noise. The water supply now remains shut until it is manually released.

Assembly:

Screw the hose burst protection device onto a water tap with a G $\frac{3}{4}$ inch right turning thread connection. The connection is self-sealing. Establish the connection between the safety kit and the chamber with a part of the supplied hose. Protect both ends of the hose by the supplied hose clamps.

We recommend connecting the hose as the last step in order to avoid twisting the hose while screwing on the safety kit.

Open the water tap slowly in order to avoid actuating the hose burst protection device.

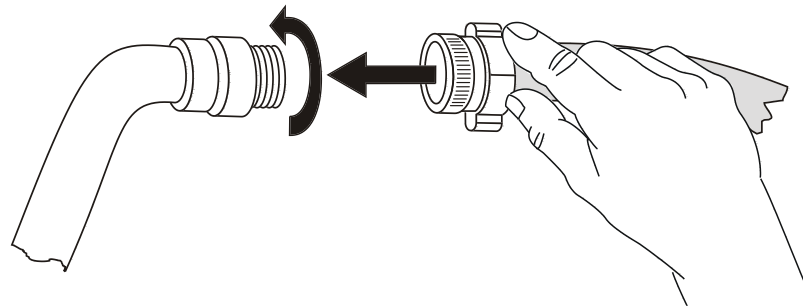



Figure 22: Assembly of the connection kit

Release of the reflux protection device:

In case the burst protection device has interrupted the water supply, first find the reason and remove it as necessary. Close the water tap. Release the valve by a half left-turn of the upper knurled part. You can hear the release of the valve as a clicking noise. Tighten the burst protection device against the water tap by a right turn. Open the water tap slowly afterwards.

Maintenance of the assembly of the hose burst protection device:

Calcification can impair valve function. We recommend an annual inspection by a skilled plumber. The plumber should remove the safety kit to check the valve by hand for proper function and calcification or blockage.

NOTICE	
	<p>Danger of impairment of valve function by calcification.</p> <p>Damage to the chamber.</p> <ul style="list-style-type: none"> ➤ Have a plumber inspect the valve annually. ➤ Remove calcifications by citric acid or acetic acid solutions. ➤ Continue by testing the function and tightness of the mounted unit.

Check: Quickly open the water tap while there is no chamber connected – the valve should cut off the water flux without any delay.



4.6 Electrical connection

The ultra-low temperature freezers UF V are supplied ready for connection and come with an IEC connector plug.

An internal overload release protects the freezer against excess-current.

Model	Plug of the power cable	Nominal voltage +/- 10% at the indicated power frequency	Current type	Fuse
UF V	Grounded plug	230 V at 50 Hz	1N~	10 A
UF V UL (120 V)	NEMA 5-15P	115 V at 60 Hz	1N~	13 A
UF V UL (208 V)	NEMA 6-15P	208-230 V at 60 Hz	2~	10 A

- The domestic socket must also provide a protective conductor. Make sure that the connection of the protective conductor of the domestic installations to the chamber's protective conductor meets the latest technology. The protective conductors of the socket and plug must be compatible!

	 DANGER
	<p>Electrical hazard due to missing protective conductor connection. Deadly electric shock</p> <p>➤ Make sure that the chamber's power plug and the power socket match and securely connect the electrical protective conductors of the chamber and the house installation.</p>

- Only use original connection cables from BINDER.
 UL chambers: Use only a UL Listed Power supply cord (UL category ELBZ), SJT 3x14 AWG (2.08 mm²); C13L. For outside USA use a certified power supply cord according to national requirements.
- Prior to connection and start-up, check the power supply voltage. Compare the values to the specified data located on the chamber's type plate (located on the left-hand side of the chamber, bottom right-hand, chap. 1.6).

	NOTICE
	<p>Danger of incorrect power supply voltage due to improper connection. Damage to the chamber.</p> <p>➤ Check the power supply voltage before connection and start-up. ➤ Compare the power supply voltage with the data indicated on the type plate.</p>

- When connecting, please observe the regulations specified by the local electricity supply company as well as the local or national electrical regulations (VDE directives for Germany).
- Observe a sufficient current protection according to the number of devices that you want to operate. We recommend the use of a residual current circuit breaker.
- Pollution degree (acc. to IEC 61010-1): 2
- Over-voltage category (acc. to IEC 61010-1): II

See also electrical data (chap. 27.3).

	<p>To completely separate the chamber from the power supply, you must disconnect the power plug. Install the chamber in a way that the power plug is easily accessible and can be easily pulled in case of danger.</p>
---	--

4.7 Advanced voltage booster (option)

With this option, a buck/boost converter automatically compensates for voltage fluctuation.

5. Functional overview of the RD4 chamber controller

The RD4 chamber controller controls the temperature inside the chamber:

You can enter the desired set point value in the “**Set points**” menu directly at the controller or use the APT-COM™ 4 Multi Management Software (option) specially developed by BINDER.

The controller offers various notifications and alarm messages with visual and audible indication. All controller settings remain valid until the next manual change. They are stored also after turning off the chamber.

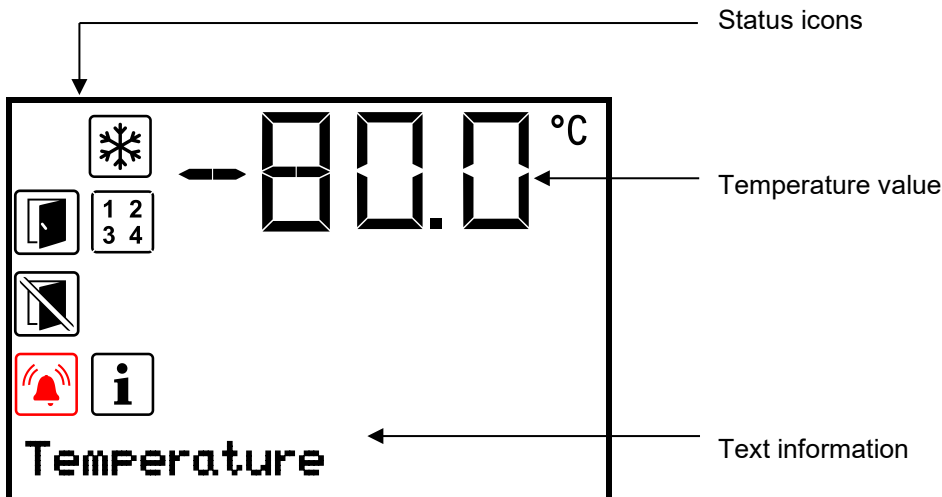













Figure 23: Normal display of the RD4 controller (sample values)

Status icons in the controller display

Icon	Signification	Icon	Signification
	Door open		Refrigeration active
	Do not open the door		Display of activated special controller functions. 1 = CO ₂ emergency cooling activated 2 = Emergency cooling test activated 3 = Service setpoint active
	Information		
	Collective alarm		

Functional controller keys

Icon	Signification	Function
	Arrow-up button	<ul style="list-style-type: none"> Navigate between menus, submenus, other functions In the setting menu: change setting, increase value
	Arrow-down button	<ul style="list-style-type: none"> Navigate between menus, submenus, other functions In the setting menu: change setting, decrease value
	OK button	<ul style="list-style-type: none"> Select menu, submenu, function In the setting menu: Confirm entry
	Back button	Back to previous menu level
	Standby button	no function

5.1 Menu structure of the controller and access levels

Starting from Normal display, navigate between the menus with the **arrow buttons**.

With the **OK button** you enter the setting of further subordinate menu functions.

With the **Back button** you go back to the previous function and finally back to Normal display.

The available functions depend on the current dependent on the current **authorization** "User", "Admin" or "Service", for which the entry of a password may be required, depending on the setting.

You can set passwords for different access levels:

- **User:** The password enables access to the standard operating functions. Factory setting is 00 00 (no password assigned).
- **Admin:** The password enables access to advanced controller functions and settings. Factory setting is 00 01.
- **Service:** The password enables access to all controller functions (for BINDER Service only).

As soon as a password has been assigned, access to the respective functions is blocked and only available after entering the correct password.

Menu	Required access level	Functions
Setpoints	"User"	<ul style="list-style-type: none"> • Temperature set-point setting • CO₂ emergency cooling set-point setting (option) • Setting the safety controller • Activating/deactivating the CO₂ emergency cooling (option) and the service setpoint, emergency cooling test (option)
Chamber info	Any user	<ul style="list-style-type: none"> • Configuration display (setup information, controller hardware and software, analog inputs) • Display of battery condition ("battery-buffered alarm system" option) • Display of interface configuration (e.g. MAC address, IP address)
Settings	"Admin"	<ul style="list-style-type: none"> • General controller settings (date, time, menu language, temperature unit, display brightness...) • Network settings • Setting the data logger storage interval • Setting the tolerance ranger limits and delay times for door open and tolerance range alarm, setting the service setpoint • Access code assignment ("door access system" option) • Password changing for User and Admin
Service	"Service"	<ul style="list-style-type: none"> • Configuration settings (only for BINDER Service) • Password changing for User and Admin
USB (visible when inserting a USB stick)	Export: Any user Import: "Admin"	<ul style="list-style-type: none"> • Export of configuration, logger, and service data • Import of configuration data

Unless noted otherwise, the figure in this manual show the functional range, which is available for the user with "Admin" authorization level

Note: When specifying the path to the respective function, the possibly required entry of a password is not listed.

6. Start up



Following transport, wait at least 8 hours until start-up.

Check that the interior of the freezer is empty. Prior to starting a new freezer or if you do not know what the freezer was last used for, for hygiene purposes you should clean and disinfect the interior (chap. 24).

After connecting the supply lines, turn on the chamber by the main power switch (4) (position 1). The lit pilot lamp shows the chamber is ready for operation.

The controller shows normal display and controls the temperature to the last entered values.

6.1 Preset factory parameters

The chamber is supplied with the following preset parameters, which can be changed in the corresponding menus:

Temperature set point	-80 °C / -112 °F
Safety controller	Set point type "Limit" -50 °C / -58 °F
The maximum permitted deviation from the temperature set point for tolerance range alarm	+/- 5 K
Alarm delay time after opening the door	1 minute
Alarm delay time after leaving the tolerance range (Following opening the door or chamber startup, the tolerance range alarm becomes valid only after the setpoint has been reached)	60 minutes
Password for "User" authorization	0 (no locking)
Password for "Admin" authorization	1

6.2 Behavior after turning on the chamber

During the equilibration phase of approx. 8 hours after turning on the chamber, undefined temperature conditions occur within the chamber. During this phase, do not place any sample materials in the chamber



NOTICE

Danger of temperature fluctuation.

Destruction of samples.

- Load the freezer only after equilibration of temperature.

If the function “Language selection at restart” has been activated (chap. 12.5, factory setting ON), the following settings are checked upon start up:

- **Menu language** (chap. 12.1):
Use the **arrow buttons** to select the desired language, confirm with the **OK button**
- **Temperature unit** (chap. 12.2):
Use the **arrow buttons** to select the desired temperature unit, confirm with the **OK button**.
- **Current date** (chap. 12.3), format DD MM YYYY:
Use the **arrow buttons** to set the day, continue with the **OK button**.
Use the **arrow buttons** to set the month, continue with the **OK button**.
Use the **arrow buttons** to set the year, confirm with the **OK button**
- **Current time** (chap. 12.4), format HH:MM:
Use the **arrow buttons** to set the hours, continue with the **OK button**.
Use the **arrow buttons** to set the minutes, confirm with the **OK button**

Set the controller to the desired temperature set point (chap. 7) used to operate the freezer.



As long as there is a difference between the actual and set value shown in the display, the intended operation of the chamber will not be ensured.

7. Temperature set-point entry

Required access level: “User”.

Setting and control range: -40 °C / -40 °F up to -90 °C / -130 °F

To set a lower setpoint value for test purposes or for adjustment, you can enter and activate a service setpoint (chap. 20). This setting is outside the control range and is not intended for normal operation.

Path: **Normal display**  **Setpoints**  **Temperature**

Press the **OK button** to enable the setting.

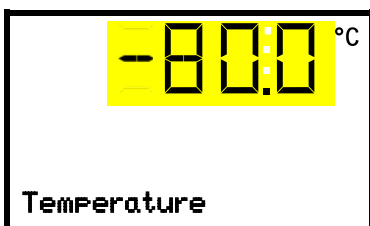

Temperature setting.
The current setting flashes. Enter the desired set-point with the **arrow buttons**.
Confirm the entry with the **OK button**.

With the **Back button** you can go back to the “**Setpoints**” submenu and, repeatedly pressing it, to **Normal display**.



With safety controller mode “Limit”, adapt the safety controller always when you changed the temperature set-point. Set the safety controller value by approx. 15 °C above the temperature set-point (chap. 11).
Recommended setting: safety controller mode “Offset” with safety controller value 15 °C.

Only insert samples into the freezer when it has reached its stable operating state.

Temperature equilibrating time to -80 °C / -112 °F is approx. 6 hours (UF V 500) / approx. 7.5 hours (UF V 700).

8. Placing samples in storage in the freezer

Before storing valuable samples, conduct a 10-days test run at the desired temperature. This helps to detect transport damages like capillary cracks. Then you can load the freezer with the precooled samples.



WARNING: If customer should use a freezer running in non-supervised continuous operation, we strongly recommend in case of inclusion of irrecoverable specimen or samples to split such specimen or samples and store them in at least two chambers, if this is feasible.

During the equilibration phase of approx. 8 hours after turning on the chamber, undefined temperature conditions occur within the chamber. During this phase, do not place any sample materials in the chamber



NOTICE

Danger of temperature fluctuation.

Destruction of samples.

- Load the freezer only after equilibration of temperature.

When placing not precooled samples in storage, temperature rises inside the freezer. We recommend to successively load the freezer. The more thermal energy you bring in, the longer it takes until reaching the set-point temperature again.

Do not exceed the maximum load of each compartment and the permitted total load (see chap.27.3).

The inner surfaces become very cold during operation. Always wear protective gloves when opening the freezer and bringing in or removing material.



CAUTION

Danger of injury by freezing on when touching cold chamber parts during operation.

Local frostbite.

- ∅ Do NOT directly touch the inner surfaces or the charging material during operation.
- ∅ AVOID skin contact with the inner surfaces and accessory equipment.
- Wear protective gloves when opening the inner doors and during manipulation.



After the outer door has been closed, it can only be opened again after a waiting time. This time depends dynamically on the length of time since the door was last opened:

- More than 7 days since the door was last opened: 90 seconds waiting time
- Less than 7 days but more than 24 hours since the door was last opened: 70 seconds waiting time
- Less than 24 hours since the door was last opened: 30 seconds waiting time

The waiting time is displayed on the controller in Normal display as a countdown. In addition, the information icon is lit, and the icon "Do not open the door" flashes.

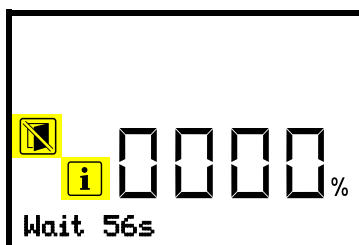

Normal display during the waiting time after the outer door has been closed (example)

Note: If the door has not been opened for a longer period of time (more than 5 days), it is advisable to de-ice the door gaskets and the inner opening of the pressure compensation valve (I) (see chap. 25.2.3). After that, the door can be opened even after a short period of time without applying great force.

9. Setting special controller functions

In the "Functions on/off" menu you can define the switching state of up to 4 controller functions.

Required access level: "User".

Path: **Normal display**  **Setpoints**   **Functions on/off**

With optional CO₂ emergency cooling:

Path: **Normal display**  **Setpoints**    **Functions on/off**

The functions are displayed from left to right.

Example: Function 1 activated = 1000. Function 1 deactivated = 0000.

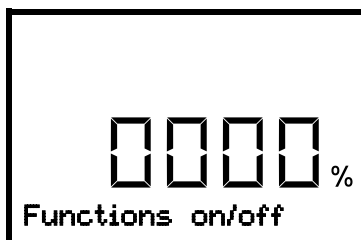

Submenu "**Functions on/off**".

This view shows the switching states of the four available functions.

"1" = Function activated

"0" = Function deactivated

Press the **OK button** to access the first individual function. With the **arrow-down button** you can proceed to the subsequent functions.

The functions 1 and 2 are only available with the chamber with optional CO₂ emergency cooling.

- Function 1 "CO₂ emer.cooling on/off": Activating the CO₂ emergency cooling, chap. 21.3.2
- Function 2 "CO₂ cooling test on/off": Test run of the CO₂ emergency cooling, chap. 21.3.3
- Function 3 "Service setpoint on/off": Activating the service setpoint, chap. 20.2
- Function 4 has no function with this chamber type.

Press the **OK button** to enable the setting of the desired function and select the function's switching state "1" (function activated) or "0" (function deactivated).

With the **Back button** you can go back to the "**Functions on/off**" submenu and, repeatedly pressing it, to **Normal display**.

In Normal display the activated functions are indicated by an icon showing the number of the respective function.

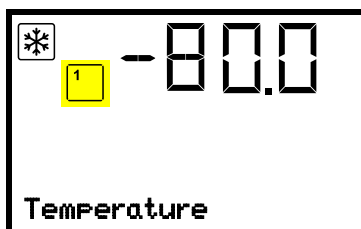

Example:

Normal display with activated function 1 "CO₂ emer.cooling on/off"



The settings for the CO₂ emergency cooling (option) are described in chap. 20.

10. Password

10.1 Password request

To access menus for which access is restricted, you must enter the corresponding password.

After calling the appropriate menu function with the **OK button** the password request appears.

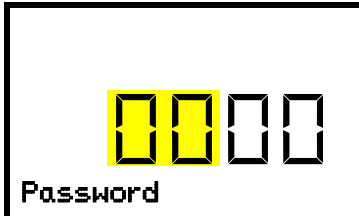

Password request.

The left two digits are flashing. Enter the desired numbers with the **arrow buttons**.

Confirm the setting with the **OK button**.

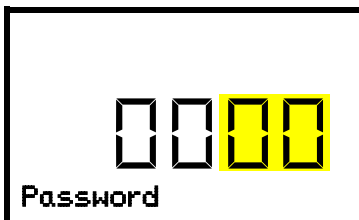

Password request.

The right two digits are flashing. Enter the desired numbers with the **arrow buttons**.

Confirm the setting with the **OK button**.

Upon entering an incorrect password, the message "Wrong password" is displayed.



Display "Wrong password".

After 3 seconds the controller changes again to the password entry.

Enter the correct password.

Following correct password entry, you can access the desired menu function.

10.2 Assign and modify a password

In this menu you can assign and modify the passwords of the "User" and "Admin" access levels.

Required access level: "Admin".

10.2.1 Assign and modify the User password

Path: **Normal display** ▾ ▾ ▾ **Settings**  **Chamber** ▾ ▾ ▾ ▾ **Password User**

Press the **OK button** to enable the setting.

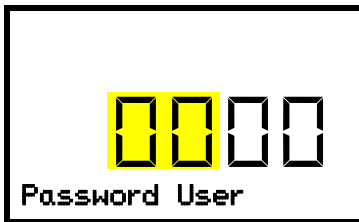

Setting the User password.
The left two digits are flashing. Enter the desired numbers with the **arrow buttons**.
Confirm the setting with the **OK button**.

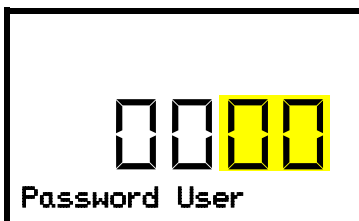

Setting the User password.
The right two digits are flashing. Enter the desired numbers with the **arrow buttons**.
Confirm the setting with the **OK button**.

With the **arrow-down button** you can now proceed to enter the Admin password.

With the **Back button** you can go back to the “**Chamber**” submenu and, repeatedly pressing it, to **Normal display**.



Keep the password well in mind. There is no access to the corresponding menu functions without the correct password.

10.2.2 Assign and modify the Admin password

Path: **Normal display** ▾ ▾ ▾ **Settings**  **Chamber** ▾ ▾ ▾ ▾ ▾ **Password Admin**

Press the **OK button** to enable the setting.



Setting the Admin password.
The left two digits are flashing. Enter the desired numbers with the **arrow buttons**.
Confirm the setting with the **OK button**.

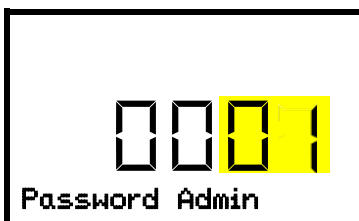

Setting the Admin password.
The right two digits are flashing. Enter the desired numbers with the **arrow buttons**.
Confirm the setting with the **OK button**.

With the **Back button** you can go back to the “**Chamber**” submenu and, repeatedly pressing it, to **Normal display**.



Keep the password well in mind. There is no access to the corresponding menu functions without the correct password.

10.3 Performance during and after power failure and shut down

Standard chamber: During a power supply failure, all controller functions are shut down.

Chamber with option “battery-buffered alarm system”: During a power supply failure the battery maintains the controller functions. The controller display is dark and can be activated for 5 seconds by pressing any button. The refrigerating machine is out of operation. The chamber’s refrigerating function can be maintained through the CO₂ emergency cooling (option, chap. 21). The zero-voltage relay alarm output (9) (chap. 14.4.7) is switched for the whole duration of the power failure.

After the power returns or when turned on by hand, all functions return to the same status the chamber had before power failure. The freezer regulates the temperature to the last entered set point.



All settings and set point values remain in the memory during power failure after power off.

If an alarm has occurred caused by the power supply failure (tolerance range, safety controller etc.), confirm the alarm. See chap. 14.

11. Safety controller (temperature safety device)

The freezer is equipped with an electronic over temperature safety device. It is designated as the “safety controller”. This second, electrically independent temperature controller takes over control at a selectable set point in case of fault. It serves to protect the charging material against excessively high temperatures. The safety controller is independent of the temperature control system. If an error occurs, it performs a regulatory function.

Please observe the regulations applicable to your country (for Germany: DGUV guidelines 213-850 on safe working in laboratories, issued by the employers’ liability insurance association).

The overtemperature safety controller serves to protect the chamber, its environment and the contents from exceeding the maximum permissible temperature. In the case of an error, it limits the temperature inside the chamber to the entered safety controller value. This condition (state of alarm) is indicated visually and additionally with an audible alert if the buzzer is enabled (chap. 14.3). The alarm persists until the chamber cools down below the configured safety controller value and the alarm is reset on the controller.



Regularly check the safety controller setting. Set the safety controller set point by approx. 15 °C above the desired temperature set point.



The safety controller only activates after the set-point has been reached once.



The settings of the safety controller are inactive during battery operation (option), open door, power failure, CO₂ emergency cooling (option). They become functional again following restitution of power supply and/or the restart of the chamber with the main power switch (4).

You can set the **safety controller mode** to “Limit” or “Offset”.

- **Limit:** Limit value, absolute maximum permitted temperature value

This setting offers high safety as a defined temperature limit will not be exceeded. It is important to adapt the safety controller value after each modification of the temperature set-point. Otherwise, the limit could be too high to ensure efficient protection, or, in the opposite case, it could prevent the controller from reaching an entered set-point outside the limit range.

- **Offset:** Offset value, maximum overtemperature above any active temperature set point. The resulting maximum temperature changes internally and automatically with every temperature set-point change.

Example:

Desired temperature value: -90 °C, desired safety controller value: -60 °C.

Possible settings for this example:

Temperature set point	Safety controller mode	Safety controller value
-90 °C	Limit	Limit value -60 °C
	Offset	Offset value 30 °C

11.1 Setting the safety controller mode

Required access level: "User".

Path: **Normal display**  **Setpoints**    **Safety controller**  **Mode**

With optional CO₂ emergency cooling:

Path: **Normal display**  **Setpoints**     **Safety controller**  **Mode**

Press the **OK button** to enable the setting.

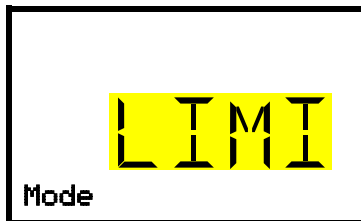

Setting the safety controller mode

The current setting flashes. Use the **arrow buttons** to select between LIMI (Limit) and OFFS (Offset).

Confirm the setting with the **OK button**.

With the **arrow-down button** you proceed to setting the safety controller value (chap. 11.2)

With the **Back button** you can go back to the "Safety controller" submenu and, repeatedly pressing it, to **Normal display**.

11.2 Setting the safety controller value

Required access level: "User".

The desired safety controller mode must be selected first (chap. 11.1). Depending on the mode setting, one of the following setting menus will appear.

Path: **Normal display**  **Setpoints**    **Safety controller**   **Limit or Offset**

With optional CO₂ emergency cooling:

Path **Normal display**  **Setpoints**     **Safety controller**   **Limit or Offset**

Press the **OK button** to enable the setting.

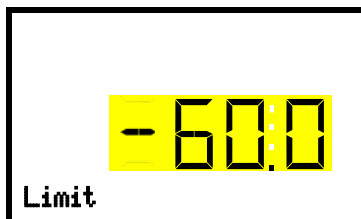

Setting the safety controller value with "Limit" safety controller mode.

The current value flashes. Enter the desired limit value with the **arrow buttons**. Setting range: -20 °C to -110 °C.

Confirm the entry with the **OK button**.

Or

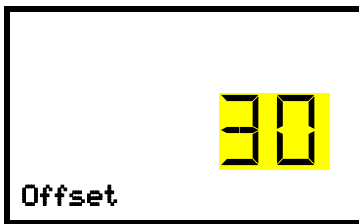

Setting the safety controller value with “Offset” safety controller mode
The current value flashes. Enter the desired offset value with the **ar-row buttons**.
Confirm the entry with the **OK button**.

With the **Back button** you can go back to the “**Safety controller**” submenu and, repeatedly pressing it, to **Normal display**.



Regularly check the settings of the safety controller mode and value.
Set the safety controller value by approx. 15 °C above the desired temperature set-point.

11.3 Message and measures in the state of alarm

The state of alarm is indicated visually in Normal display. If the buzzer is enabled (chap. 14.3) there is an additional audible alert. A text message indicates the alarm cause. The “collective alarm” icon is lit. If the audible arm is activated, the buzzer sounds. Press the **OK button** to mute the buzzer.

The alarm message “Safety controller” and the “Collective alarm” icon are displayed on the controller until you press the **OK button** on the controller **and** the inner chamber temperature has cooled down below the safety controller value.

- If the inner chamber temperature has already cooled down below the safety controller value when pressing the **OK button**, the alarm message “Safety controller” and the “Collective alarm” icon are reset together with the buzzer.
- If the state of alarm is still active when pressing the **OK button**, i.e. the inner chamber temperature is still above the safety controller value, first only the buzzer is reset. The alarm message “Safety controller” and the “Collective alarm” icon will disappear as soon as the inner chamber temperature falls below the safety controller value.

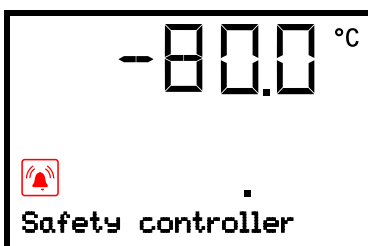

Normal display showing safety controller alarm (sample value)

Note:

When the safety controller had been activated you should disconnect the chamber from the power supply and have an expert examine and rectify the cause of the fault.

11.4 Function check

Check the safety controller at appropriate intervals for its functionality. It is recommended that the authorized operating personnel should perform such a check, e.g., before starting a longer work procedure.

12. General controller settings

The general settings can be accessed in the “**Settings**” submenu, which is available for users with “Service” or “Admin” authorization level. It serves to enter date and time, select the language for the controller menus and the desired temperature unit and to configure the controller’s communication functions.

The display of some network settings is available for all users in the “**Chamber info**” menu.

12.1 Selecting the controller’s menu language

The RD4 controller communicates by a menu guide using real words in German, English, French, Spanish, and Italian languages.

Required access level: “Admin”. Following start-up of the chamber (chap. 6), it is “User”.

Path: **Normal display**    **Settings**  **Chamber**    **Language***

* Following start-up of the chamber: **Sprache / Language / Langue**, depending on the language selected before turning off the chamber

Press the **OK button** to enable the setting.

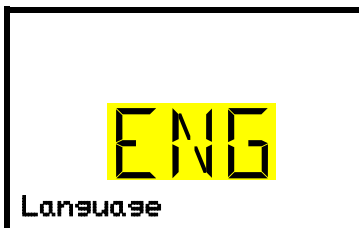

Setting the menu language (example: English).

The current setting flashes. Use the **arrow buttons** to select the desired language.

Confirm the entry with the **OK button**.

With the **arrow-down button (twice)** you can now change to the temperature unit setting.

With the **Back button** you can go back to the “**Chamber**” submenu and, repeatedly pressing it, to **Normal display**.

12.2 Selecting the temperature unit

Required access level: “Admin”. Following start-up of the chamber (chap. 6), it is “User”.

Path: **Normal display**    **Settings**  **Chamber**     **Temperature unit**

Press the **OK button** to enable the setting.

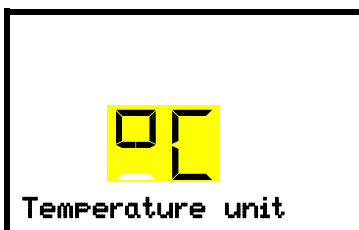

Setting the temperature unit

The current setting flashes. Use the **arrow buttons** to select between °C (degrees Celsius) and °F (degrees Fahrenheit).

Confirm the entry with the **OK button**.

You can change the temperature unit between °C and °F.

If the unit is changed, all values are converted accordingly

	C = degree Celsius	0 °C = 31 °F	Conversion: [value in °F] = [value in °C] * 1,8 + 32
	F= degree Fahrenheit	100 °C = 212 °F	

With the **Back button** you can go back to the “**Chamber**” submenu and, repeatedly pressing it, to **Normal display**.

12.3 Setting the current date

Required access level: "Admin". Following start-up of the chamber (chap. 6), it is "User".

Path: **Normal display**    **Settings**  **Chamber**  **Date**

Press the **OK button** to enable the setting.

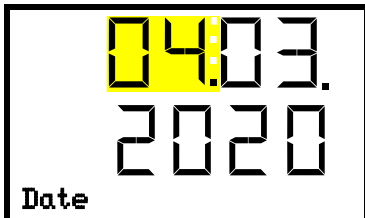

Setting the date: day
The current setting flashes. Enter the current day with the **arrow buttons**.
Confirm the entry with the **OK button**.

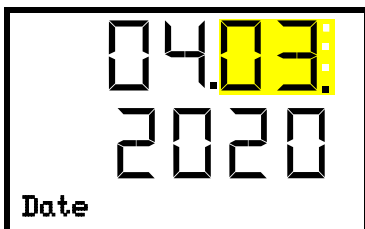

Setting the date: month
The current setting flashes. Enter the current month with the **arrow buttons**.
Confirm the entry with the **OK button**.

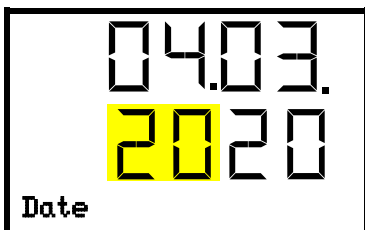

Setting the date: year
The left two digits are flashing. Enter the first two digits of the current year with the **arrow buttons**.
Confirm the entry with the **OK button**.

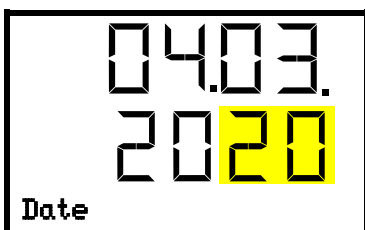

Setting the date: year
The right two digits are flashing. Enter the last two digits of the current year with the **arrow buttons**.
Confirm the entry with the **OK button**.

With the **arrow-down button** you can now change to setting the current time.

With the **Back button** you can go back to the "Chamber" submenu and, repeatedly pressing it, to **Normal display**.



Check the date when you use the chamber for the first time or when you change local summer time and adjust it if necessary.

12.4 Setting the current time

Required access level: "Admin". Following start-up of the chamber (chap. 6), it is "User".

Path: **Normal display**    **Settings**  **Chamber**   **Time**

Press the **OK button** to enable the setting.

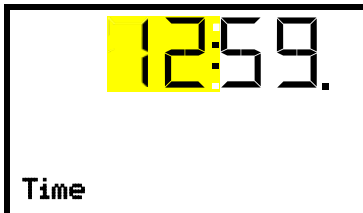

Setting the time: hours
The current setting flashes. Enter the current hour with the **arrow buttons**.
Confirm the entry with the **OK button**.

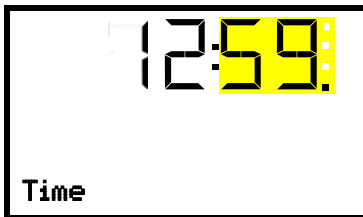

Setting the time: minutes
The current setting flashes. Enter the current minutes with the **arrow buttons**.
Confirm the entry with the **OK button**.

With the **Back button** you can go back to the "Chamber" submenu and, repeatedly pressing it, to **Normal display**.

12.5 Function "Language selection at restart"

If the function "Language selection at restart" is activated, menu language, date, time, and temperature unit are checked with every startup of the chamber. At this occasion it is also possible to modify them with "User" access level.

Required access level: "Admin".

Path: **Normal display**    **Settings**  **Chamber**     **Language selection at restart**

Press the **OK button** to enable the setting.



Function "Language selection at restart"
The current setting flashes. Use the **arrow buttons** to select between ON and OFF.
Confirm the setting with the **OK button**.

With the **arrow-down button** you can now change to the next parameter (chamber address).

With the **Back button** you can go back to the "Chamber" submenu and, repeatedly pressing it, to **Normal display**.

12.6 Setting the chamber address

This setting is required for the communication with the BINDER APT-COM™ 4 Multi Management Software. The chamber address settings in the chamber controller and in the software must be identical.

Required access level: "Admin".

Path: **Normal display** ▾ ▾ ▾ **Settings** **Chamber** ▾ ▾ ▾ ▾ **Chamber address**

Press the **OK button** to enable the setting.



Setting the chamber address

The current setting flashes. Enter the desired address with the **arrow buttons**. Setting range: 1 up to 254

Confirm the entry with the **OK button**.

With the **arrow-down button** you can now change to the next parameter (display brightness).

With the **Back button** you can go back to the "Chamber" submenu and, repeatedly pressing it, to **Normal display**.

12.7 Display brightness

Required access level: "Admin".

Path: **Normal display** ▾ ▾ ▾ **Settings** **Chamber** ▾ ▾ ▾ ▾ ▾ **Brightness**

Press the **OK button** to enable the setting.



Setting the display brightness

The current setting flashes. Enter the desired value with the **arrow buttons**. Setting range: 10% up to 100%

Confirm the entry with the **OK button**.

With the **arrow-down button** you can now change to the next parameter (audible alarm, chap. 14.3).

With the **Back button** you can go back to the "Chamber" submenu and, repeatedly pressing it, to **Normal display**.

13. Tolerance range and alarm delay settings

In this menu you can define the deviation between the actual value and setpoint of, which that shall cause a tolerance range alarm. The entered value defines the limit of permitted deviations from the set-point (exceeding and falling below). Reaching this limit triggers tolerance alarm.

In addition, you can specify delay times for the tolerance range alarm and the door open alarm.

During the delay time there is no alarm message after leaving the tolerance range:

- After door opening: fixed delay time of 1 hour
- After turning on the chamber or returning power supply or after a door opening in case the set-point hasn't been reached: fixed delay time of 15 hours
- After leaving the tolerance range in normal operation: adjustable delay time (chap. 13.2)

If the actual value is outside the tolerance range, after the configured alarm delay time the alarm message "Temperature range" is displayed in Normal display (chap. 14.1). If the alarm buzzer is activated (chap. 14.3) there is an audible alert.

This function only activates after the set-point has been reached once.

Required access level: "Admin".

13.1 Setting the delay time for door open alarm

Path: **Normal display** ▾ ▾ ▾ **Settings** ▾ ▾ ▾ **Various** **Door alarm delay (min)**

Press the **OK button** to enable the setting.

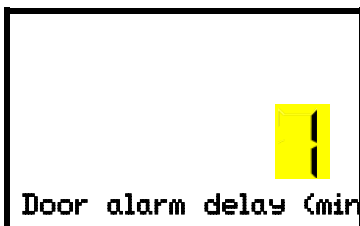

Setting the door alarm delay.

The current setting flashes. Use the **arrow buttons** to enter the desired time after which the door open alarm shall be triggered. Entry range: 1 up to 600 minutes. Factory setting: 1 minute.

Confirm the entry with the **OK button**.

With the **arrow-down button** you can now change to the tolerance range alarm delay setting.

With the **Back button** you can go back to the "Various" submenu and, repeatedly pressing it, to **Normal display**.

13.2 Setting the delay time for tolerance range alarm

Following opening the door or chamber startup, the tolerance range alarm becomes valid only after the setpoint has been reached.

Path: **Normal display** ▾ ▾ ▾ **Settings** ▾ ▾ ▾ **Various** **Range alarm delay (min)**

Press the **OK button** to enable the setting.

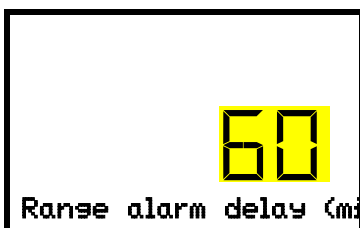

Setting the tolerance range alarm delay.

The current setting flashes Use the **arrow buttons** to enter the desired time after which the range alarm shall be triggered. Entry range: 1 up to 300 minutes. Factory setting: 60 minutes.

Confirm the entry with the **OK button**.

With the **arrow-up button** you can go back to the door alarm delay setting.

With the **arrow-down button** you can now change to the temperature tolerance range setting.

With the **Back button** you can go back to the “**Various**” submenu and, repeatedly pressing it, to **Normal display**.

13.3 Setting the temperature tolerance range

The temperature range is defined symmetrically around the setpoint. If the actual temperature value lies within this tolerance range and subsequently leaves and the tolerance range, tolerance range alarm is triggered after the set adjustable delay time (chap. 13.2)

Path: **Normal display**    **Settings**     **Various**    **Temperature range**

Press the **OK button** to enable the setting.

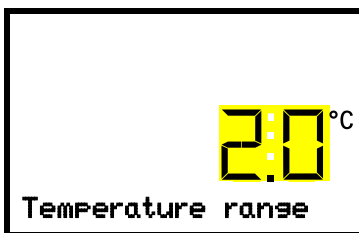

Setting the temperature tolerance range
 The current setting flashes. Enter the desired temperature range with the **arrow buttons**. Entry range: 1,0 °C up to 10,0 °C. Factory setting: +/- 5 K
 Confirm the entry with the **OK button**.

With the **arrow-up button** you can go back to the tolerance range alarm delay setting.

With the **arrow-down button** you can now change to the service setpoint setting (chap. 20.1).

With the **Back button** you can go back to the “**Various**” submenu and, repeatedly pressing it, to **Normal display**.

14. Alarm functions

14.1 Alarm messages



WARNING: If customer should use a chamber running in non-supervised continuous operation, we strongly recommend in case of inclusion of irrecoverable specimen or samples to split such specimen or samples and store them in at least two chambers, if this is feasible.

In the event of equipment failures, when the temperature deviates from the set tolerance range limits, optical and possibly acoustic alarm messages are given out via the controller. A zero-voltage relay alarm output (9) (chap. 14.4.7) permits transmission of the alarm e.g., to a central monitoring system.

The alarm messages door open and leaving the tolerance range are emitted after a configurable delay (chap. 13), the others immediately when the fault occurs. The tolerance range alarm is suppressed after opening the chamber door or turning on the freezer until the setpoint is reached and then for the selected delay time.



In Normal display a text message indicates the alarm cause. The “collective alarm” icon flashes. If the audible alarm is activated, the buzzer sounds.

If more than one alarm signal is sent simultaneously, they are displayed in a cycle.

Press the **OK button** to confirm the alarm and mute the buzzer. If the alarm cause is still valid, the “collective alarm” icon is lit.



Alarm indication (example: safety controller alarm)

Alarm messages overview:

Condition	Alarm message	Moment of Alarm message and switching the zero-voltage relay alarm output
Chamber door open	“Door open”	after configurable time (chap. 13). Factory setting: 1 minute
Exceeded setpoint of the safety controller	“Safety controller”	immediately
The current actual temperature value is outside the tolerance range (chap. 13)	“Temp. range”	after configurable time (chap. 13). Factory setting: 60 minutes
Continuous compressor operation, refrigeration system defective. Contact BINDER Service.	“Continuous operation”	<ul style="list-style-type: none"> • 12 hours after start-up or a door opening, if the set-point wasn't reached • 60 minutes after reaching the set-point
Clean / replace the condenser air filter (chap. 25.2.1)	“Condenser temp.”	immediately
Compressor defective. Contact BINDER Service.	“Compressor defective”	immediately
Inner temperature sensor defective. Control continues using the safety controller temperature sensor	“Inner temp. sensor”	immediately

Condition	Alarm message	Moment of Alarm message and switching the zero-voltage relay alarm output
Safety controller temperature sensor defective	"Safety control sensor"	immediately
Inner temperature sensor and safety controller temperature sensor defective. Refrigeration is turned on permanently.	Temperature display shows " - - - - " or "<-<-< " or ">->->" Messages alternating: Inner temp. sensor and Safety control sensor	immediately
Failure of Pt100 temperature sensor on the condenser of the refrigerating machine. Refrigeration is turned on permanently.	"Condensate temp. sensor"	immediately
Failure of Pt100 temperature sensor on the cascade of the refrigerating machine.	"Cascade temp. sensor"	immediately
Failure of Pt100 temperature sensor for ambient temperature or air intake of the 1 st stage cooling (refrigerating machine).	"Ambient temp. sensor"	immediately
<i>Chamber with options "battery-buffered alarm system" and CO₂ emergency cooling:</i> Battery operation (during power failure)	"Battery operation"	immediately
<i>Chamber with optional "battery-buffered alarm system":</i> No battery recognized. Cause: Battery missing or defective. Message on line power.	"Battery defective"	immediately
<i>Chamber with optional CO₂ emergency cooling:</i> activated CO ₂ emergency cooling automatically turned on due to power failure and is running.	"CO ₂ emergency cooling"	immediately
<i>Chamber with optional CO₂ emergency cooling:</i> Insufficient CO ₂ supply of the activated CO ₂ emergency cooling system	"CO ₂ pressure"	immediately
Power failure (chamber without battery or with message "Battery defective")	--	immediately (alarm output only)

Press the **OK button** to confirm the alarm.

- Confirmation while the state of alarm persists: Only the buzzer is muted. The visual alarm message continues to be displayed until the alarm condition is removed. Then it is reset automatically.
- Confirmation after the alarm has ended: The buzzer and the visual alarm message are reset together.

14.2 Information messages

Information messages provide information about settings made and the condition of the optional battery.

 In Normal display a text message indicates the condition. The “Information” icon is lit.

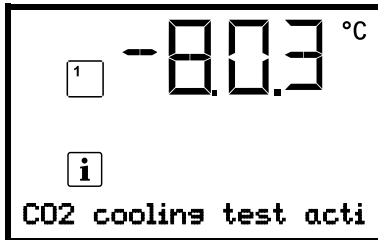

Information message (example: CO₂ emergency cooling test run is active)

Information messages overview:

Condition	Information message	Moment of information message
<p>Chamber with optional “battery-buffered alarm system”: very low battery voltage (1 V to 11 V).</p> <p>Chamber with options “battery-buffered alarm system” and CO₂ emergency cooling: Low battery voltage during CO₂ emergency cooling on battery power.</p> <p>Message on battery power and line power.</p>	“Low battery voltage”	immediately
Service setpoint is active	“Service setpoint active”	immediately
Emergency cooling test run is active	“CO ₂ cooling test active”	immediately

14.3 Activating / deactivating the audible alarm (alarm buzzer)

Path: **Normal display**    **Settings**  **Chamber**         **Audible alarm**

Press the **OK button** to enable the setting.

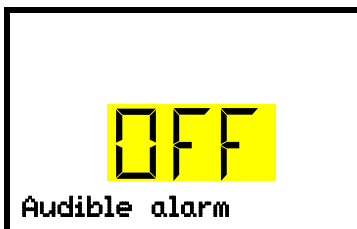

Setting the audible alarm.

The current setting flashes. Use the **arrow buttons** to select between ON and OFF.

Confirm the setting with the **OK button**.

With the **Back button** you can go back to the “Chamber” submenu and, repeatedly pressing it, to **Normal display**.

14.4 Required actions in case of an alarm



Only qualified service personnel authorized by BINDER must perform repair. Repaired chambers must comply with the BINDER quality standards.

14.4.1 Safety controller temperature alarm

The selected temperature value of the safety controller was exceeded.

The alarm occurs immediately.

- Alarm message “Safety controller”, “collective alarm” icon
- Audible alarm (buzzer)
- Switching the zero-voltage relay alarm output

Actions:

- Check whether the outer door was open for a long time or is not closed properly. Close the door if necessary. With open door there can be additional door open alarm.
- Check the setting of the safety controller (chap. 11). The limit temperature should be approx. by 15 K above the temperature set point. If necessary, adjust the relevant value.
- Check whether samples were inserted into the freezer that may release heat.
- Check the ambient conditions. Protect the freezer from direct sunlight. Ensure sufficient ventilation around the installation location to prevent any buildup of heat in the chamber.
- If these points do not reveal the source of the fault, it may be that the chamber is faulty. Please contact BINDER Service.

14.4.2 Temperature tolerance range alarm (too high and too low temperature)

The tolerance range alarm becomes valid only after the setpoint has been reached.

When the actual temperature value leaves the tolerance range the alarm occurs after the defined delay time (chap. 13). Factory setting: 60 minutes.

- Alarm message “Temp. range”, “collective alarm” icon
- Audible alarm (buzzer)
- Switching the zero-voltage relay alarm output

Actions:

- Factory setting is +/- 5 K.
- Use the actual temperature displayed on the controller to verify whether the temperature alarm threshold has been breached, i.e., too cold or too warm.

Temperature too low (under temperature alarm):

- Input of large quantities of samples which were precooled with liquid nitrogen. Reset the alarm with the **OK button**.
- Possible cause: Continuous operation of the refrigeration machine after failure of one or several temperature sensors (chap. 14.4.6). In addition, there is continuous operation alarm. Contact BINDER Service.

Temperature too high (over temperature alarm):

- Check whether the outer door was open for a long time or is not closed properly. Close the door if necessary. In addition, there is door open alarm.
- Check the door gaskets for damage. Replace any damaged gaskets.
- Check whether there is icing around the gaskets. Defrost, if necessary.
- Check whether samples were inserted into the freezer that may release heat.
- Check the ambient conditions. Protect the freezer from direct sunlight. Ensure sufficient ventilation around the installation location to prevent any buildup of heat in the chamber.
- If these points do not reveal the source of the fault, it may be that the chamber is faulty. Please contact BINDER Service.



If the same alarm recurs, please contact BINDER Service.

14.4.3 Door open alarm

The open and closed condition of the chamber door is controlled via the door contact switch. The temperature rise, when the door is opened, causes the refrigerating machine to turn on.

When the door is opened the alarm occurs after the defined delay time (chap. 13), factory setting: 1 minute.

- Alarm message “Door open”, “collective alarm” icon
- Audible alarm (buzzer)
- Switching the zero-voltage relay alarm output

Actions:

- Close the outer door.
- Use the **OK button** to switch off the buzzer even when the door is open.
- The alarm message is cancelled.
- The zero-voltage relay alarm output switches off.

14.4.4 Power failure alarm (chamber with option “battery-buffered alarm system”)

- No alarm message (display is off)
You can turn on the display with the **OK button**. It turns off automatically after 10 seconds.
- Audible alarm (buzzer): immediately
- Switching the zero-voltage relay alarm output.



WARNING: If customer should use a chamber running in non-supervised continuous operation, we strongly recommend in case of inclusion of irrecoverable specimen or samples to split such specimen or samples and store them in at least two chambers, if this is feasible.

14.4.5 Messages on the battery management system (chamber with option “battery-buffered alarm system”)

The alarms and information messages occur immediately.

Battery operation

- Alarm message “Battery operation”, “collective alarm” icon
- Audible alarm (buzzer)
- Switching the zero-voltage relay alarm output
- The message occurs on battery power (during power failure) after pressing the **OK button** (see chap. 10.3)

There is sufficient battery voltage.

Battery missing, completely empty (< 3V) or defective.

- Alarm message “Battery defective”, “collective alarm” icon
- Audible alarm (buzzer)
- Switching the zero-voltage relay alarm output

The message occurs on line power when no battery has been recognized.

Actions:

- With defective battery: replace battery.
- Reset alarm message. It will not reset automatically.

Low battery voltage

Information message “Low battery voltage”, “Information” icon

The message occurs on battery power and line power.

Battery voltage is very low (< 12 V). If this message lasts for more than 2 hours, the battery can be defective.

Actions:

- Check the power supply.
- Check the charging voltage in the controller menu (chap. 19.2)
- With defective battery: replace battery. Contact BINDER Service.
- Reset alarm message. It will not reset automatically.

14.4.6 Messages referring to temperature sensor failure

The alarms occur immediately.

- Audible alarm (buzzer)
- Switching the zero-voltage relay alarm output

Failure of the temperature sensor for interior measurement:

- Alarm message “Inner temp. sensor”, collective alarm icon
- Cause: defective inner temperature sensor
- Temperature control continues using the safety controller temperature sensor

Failure of the safety controller temperature sensor:

- Alarm message “Safety control sensor”, collective alarm icon
- Cause: defective safety controller temperature sensor

Failure of both the temperature sensors for interior measurement and the safety controller:

- Temperature display shows “- - -” or “<-<-<” or “>->->”
- Alarm messages “Inner temp. sensor” and “Safety control sensor” alternating, collective alarm icon
- Cause: both the temperature sensors for interior measurement and the safety controller are defective
- Refrigeration is turned on permanently.

Failure of temperature sensors of the refrigerating machine:

- Alarm message “Condensate temp. sensor”, collective alarm icon
Cause: defective temperature sensor on the condenser of the refrigerating machine
- Alarm message “Cascade temp. sensor”, collective alarm icon
Cause: defective temperature sensor on the cascade of the refrigerating machine
If this sensor fails, refrigeration is turned on permanently.
- Alarm message “Ambient temp. sensor”, collective alarm icon
Cause: defective temperature sensor for ambient temperature or air intake of the 1st stage cooling

Actions:

- Please contact BINDER Service.
- If the temperature rises, i.e. the refrigerating machine is defective (safety controller temperature alarm and / or tolerance range alarm):
 - Transfer the material to another freezer.
 - Turn off the freezer.
 - If necessary, clean and disinfect the freezer.

14.4.7 Messages referring to CO₂ emergency cooling (option CO₂ emergency cooling)

The alarms and information messages occur immediately.

CO₂ emergency cooling is activated

- No message, icon for function 1 is shown (chap. 21.3.2)

CO₂ emergency cooling is running (test run)

Information message “CO₂ cooling test active”, information icon

Cause: CO₂ emergency cooling test run has been activated in the controller (chap. 21.3.3)

Actions:

If desired, deactivate CO₂ emergency cooling test run in the controller (chap. 21.3.3)

CO₂ emergency cooling is running (power failure)

- Alarm message “CO₂ emergency cooling”, collective alarm icon
- Audible alarm (buzzer)
- Switching the zero-voltage relay alarm output

Cause: Power failure. Activated CO₂ emergency cooling automatically turned on and is running.

Insufficient CO₂ supply of the CO₂ emergency cooling system

- Alarm message “CO₂ pressure”, collective alarm icon
- Audible alarm (buzzer)
- Switching the zero-voltage relay alarm output

Cause: emergency cooling has been activated, CO₂ connection pressure is too low.

Actions:

- Check if the CO₂ gas supply is open
- Connect a new pressurized CO₂ cylinder



It is not possible to determine the filling level of a pressurized CO₂ cylinder from the cylinder pressure. Weigh the bottle regularly in order to replace it in time

Low battery voltage during CO₂ emergency cooling with battery operation

- Information message “Low battery voltage”, information icon.
- Battery voltage is very low (< 12 V).

Actions:

- Check the battery connections
- Charge the battery (charging mode: current, approx. 160 mA)
- If it is defective, replace the battery. Contact BINDER Service
- Reset the alarm message.

14.5 Zero-voltage relay alarm output

Collective alarm output via the zero-voltage relay alarm contact

The freezer is equipped at the rear with a zero-voltage relay output (9), which permits the transmission of alarms to an external monitoring system in order to monitor and record the alarm signals.

The zero-voltage relay alarm output switches immediately, as soon as the “Collective alarm” icon lights up. The zero-voltage relay alarm output switches for all alarm instances and in case of a power failure.

If the external alarm monitor is connected via the contacts C and NO, alarm monitoring will take place with protection against short-circuiting, i.e., if the connection between the freezer and the external alarm monitor is interrupted, an alarm is triggered. In this case, power failure will also trigger the alarm.



Figure 24: Zero-voltage contacts circuit diagram and pin allocation of DIN socket (9)

When the chamber is running and there is no alarm, contact C closes with contact NO.

When the chamber is turned off or if there is an active alarm, contact C closes with contact NC.

Maximum loading capacity of the switching contacts: 24V AC/DC – 2.0 Amp.

	DANGER
	<p>Electrical hazard through overload of switching contacts. Deadly electric shock, damage to switching contacts and connection socket.</p> <ul style="list-style-type: none"> ∅ Do NOT exceed the maximum switching load of 24V AC/DC – 2.0 Amp. ∅ Do NOT connect any devices with a higher loading capacity.

The alarm message on the controller display remains displayed during transmission of an alarm via the zero-voltage relay outputs. As soon as the cause of the alarm is rectified, or the alarm message has been reset, the alarm transmission via the zero-voltage relay outputs is reset together with the alarm message on the controller display.

In case of power failure, transmission of the alarm via zero-voltage relay outputs remains active for the duration of the power failure. Afterwards, the contact closes automatically.

Connection to an external monitoring system

To ensure short-circuit-proof alarm monitoring that will trigger the alarm when the freezer is connected to an external alarm monitor, connect the external alarm monitoring system to the freezer via the connection socket (9) of the zero-voltage relay output.

15. Ethernet network settings

The settings of this submenu are used for networking chambers with an Ethernet interface, e.g. to connect them with BINDER's APT-COM™ 4 Multi Management Software (option, chap. 22.2).

15.1 Showing the network settings

Required access level: "User".

The "Ethernet" submenu offers to subsequently or individually access the following information:

- MAC address
- IP address
- Subnet mask
- Standard gateway
- DNS server address
- DNS chamber name

15.1.1 Showing the chamber's MAC address

Path: **Normal display**   **Chamber info**      **Ethernet**  **MAC address**

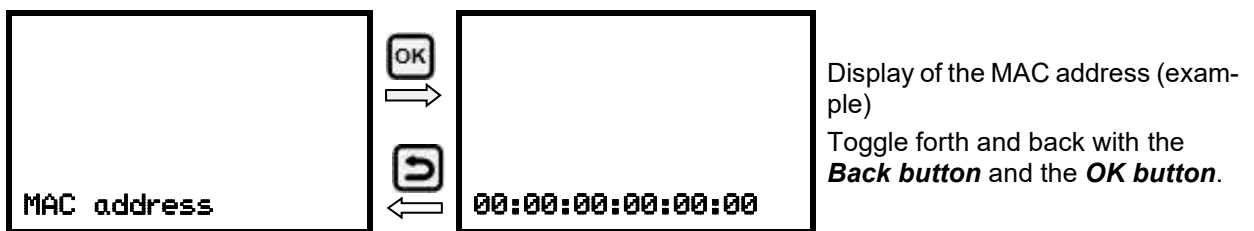

With the **arrow-down button** you can now change to the next parameter (IP address).

With the **Back button** you can go back to the "Ethernet" submenu and, repeatedly pressing it, to **Normal display**.

15.1.2 Showing the IP address

Path: **Normal display**   **Chamber info**      **Ethernet**   **IP address**

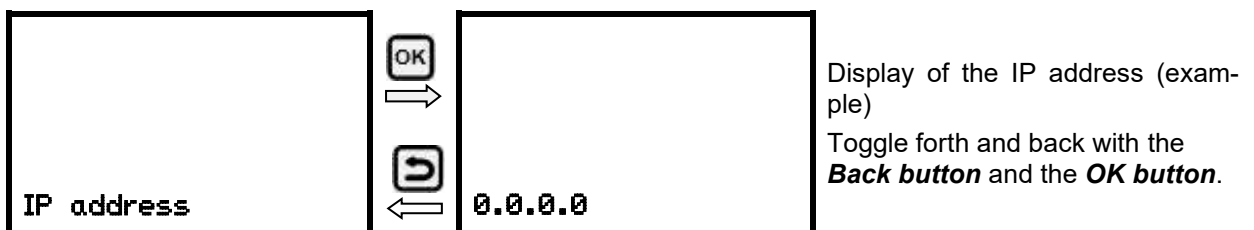

With the **arrow-down button** you can now change to the next parameter (subnet mask).

With the **Back button** you can go back to the "Ethernet" submenu and, repeatedly pressing it, to **Normal display**.

15.1.3 Showing the subnet mask

Path: **Normal display** ▾ ▾ **Chamber info** ▾ ▾ ▾ ▾ ▾ **Ethernet** ▾ ▾ **Subnet mask**

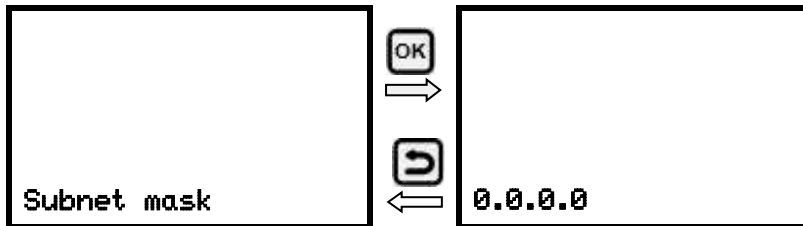

Display of the subnet mask (example)
Toggle forth and back with the **Back button** and the **OK button**.

With the **arrow-down button** you can now change to the next parameter (standard gateway).

With the **Back button** you can go back to the “**Ethernet**” submenu and, repeatedly pressing it, to **Normal display**.

15.1.4 Showing the standard gateway

Path: **Normal display** ▾ ▾ **Chamber info** ▾ ▾ ▾ ▾ ▾ **Ethernet** ▾ ▾ ▾ **Standard gateway**

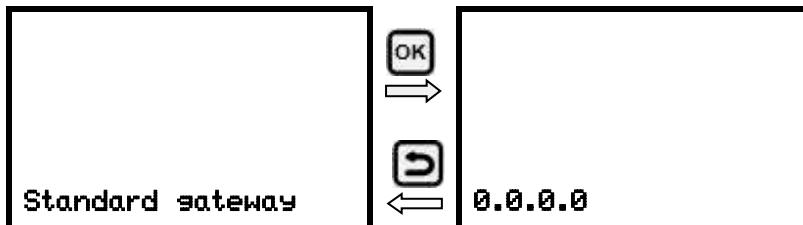

Display of the standard gateway (example)
Toggle forth and back with the **Back button** and the **OK button**.

With the **arrow-down button** you can now change to the next parameter (DNS server address).

With the **Back button** you can go back to the “**Ethernet**” submenu and, repeatedly pressing it, to **Normal display**.

15.1.5 Showing the DNS server address

Path: **Normal display** ▾ ▾ **Chamber info** ▾ ▾ ▾ ▾ ▾ **Ethernet** ▾ ▾ ▾ **DNS server address**

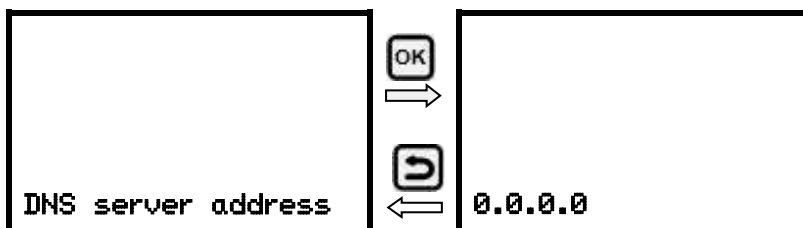

Display of the DNS server address (example)
Toggle forth and back with the **Back button** and the **OK button**.

With the **arrow-down button** you can now change to the next parameter (DNS chamber name).

With the **Back button** you can go back to the “**Ethernet**” submenu and, repeatedly pressing it, to **Normal display**.

15.1.6 Showing the DNS chamber name

Path: **Normal display** ▾ ▾ **Chamber info** OK ▾ ▾ ▾ ▾ ▾ **Ethernet** OK ▾ ▾ ▾ ▾ ▾ **DNS chamber name**

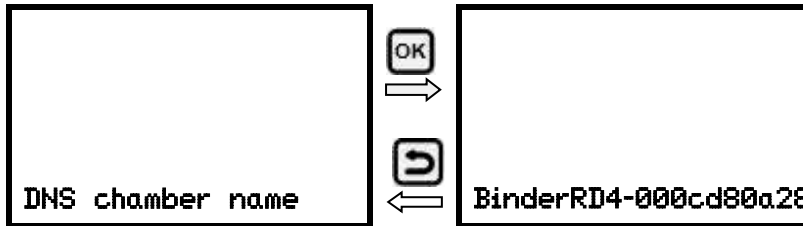

Display of the DNS chamber name (example)
Toggle forth and back with the **Back button** and the **OK button**.

With the **Back button** you can go back to the **“Ethernet”** submenu and, repeatedly pressing it, to **Normal display**.

15.2 Changing the configuration of the network settings

Required access level: “Admin”.

The “Ethernet” submenu offers to subsequently or individually access the following settings:

- Selecting the type of assignment (automatic or manual) of the IP address, chap. 15.2.1

If automatic IP address assignment has been selected:

- Selecting the type of assignment (automatic or manual) of the DNS server address, chap. 15.2.2

If manual IP address assignment has been selected:

- Assigning the IP address, chap. 15.2.3
- Assigning the subnet mask, chap. 15.2.4
- Assigning the standard gateway, chap. 15.2.5

If manual IP address assignment or manual DNS server address assignment has been selected:

- Assigning the DNS server address, chap. 15.2.6

15.2.1 Selecting the type of IP address assignment (automatic / manual)

Path: **Normal display** ▾ ▾ ▾ **Settings** OK ▾ **Ethernet** OK **IP address assignment**

Press the **OK button** to enable the setting



Selection of the type of assignment of the IP address.

The current setting flashes. Use the **arrow buttons** to select between AUTO (automatic) and MANU (manual).

Confirm the setting with the **OK button**.

With the **arrow-down button** you can now change to the next parameter.

- If manual IP address assignment has been selected: assign the IP address (chap. 15.2.3)
- If automatic IP address assignment has been selected: select the type of assignment of the DNS server address (chap. 15.2.2).

With the **Back button** you can go back to the **“Ethernet”** submenu and, repeatedly pressing it, to **Normal display**.

15.2.2 Selecting the type of assignment of the DNS server address (automatic / manual)

Access to this function is possible only if automatic IP address assignment has been selected (chap. 15.2.1).

Path: **Normal display**    **Settings**   **Ethernet**    **DNS server**

Press the **OK button** to enable the setting.

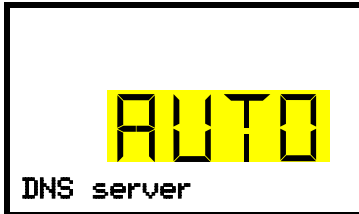

Selection of the type of assignment of the DNS server address.

The current setting flashes. Use the **arrow buttons** to select between AUTO (automatic) and MANU (manual).

Confirm the setting with the **OK button**.

If manual assignment of the DNS server address has been selected, you can now change with the **arrow-down button** to assign the DNS server address (chap. 15.2.6).

With the **Back button** you can go back to the **"Ethernet"** submenu and, repeatedly pressing it, to **Normal display**.

15.2.3 Assigning the IP address

Access to this function is possible only if manual IP address assignment has been selected (chap. 15.2.1)

Path: **Normal display**    **Settings**   **Ethernet**    **IP address**

Press the **OK button** to enable the setting.

The IP address entry is done in four steps, corresponding to the number sections: (1).(2).(3).(4)

Principle of entry:

- Use the **OK button** to select the desired section of the IP address 1/4, 2/4, 3/4, 4/4 in the upper display line
- Use the **Arrow buttons** to enter the value for the selected section of the IP address



IP address assignment (sample values).

The first section of the IP address is shown. Enter the desired value with the **arrow buttons**.

Use the **OK button** to confirm the entry and proceed to the second section of the IP address.

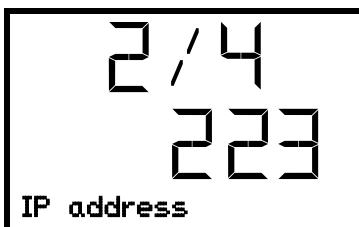

IP address assignment (sample values).

The second section of the IP address is shown. Enter the desired value with the **arrow buttons**.

Use the **OK button** to confirm the entry and proceed to the third section of the IP address.

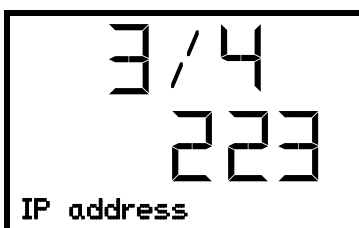

IP address assignment (sample values).

The third section of the IP address is shown. Enter the desired value with the **arrow buttons**.

Use the **OK button** to confirm the entry and proceed to the last section of the IP address.

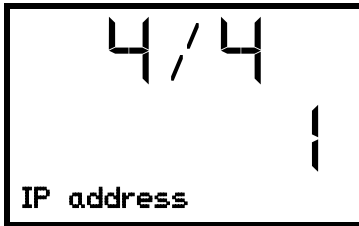

IP address assignment (sample values).

The fourth section of the IP address is shown. Enter the desired value with the **arrow buttons**.

Confirm the setting with the **OK button**.

With the **arrow-down button** you can now change to the enter the subnet mask.

With the **Back button** you can go back to the “Ethernet” submenu and, repeatedly pressing it, to **Normal display**.

15.2.4 Setting the subnet mask

Access to this function is possible only if manual IP address assignment has been selected (chap. 15.2.1)

Path: **Normal display**    **Settings**   **Ethernet**     **Subnet mask**

Press the **OK button** to enable the setting.

The subnet mask entry is done in four steps, corresponding to the number sections: (1).(2).(3).(4)

Principle of entry:

- Use the **OK button** to select the desired section of the subnet mask 1/4, 2/4, 3/4, 4/4 in the upper display line
- Use the **Arrow buttons** to enter the value for the selected section of the subnet mask

For details please refer to the description of the similar procedure in chap. 15.2.3 “Assigning the IP address”.

With the **arrow-down button** you can now change to the enter the standard gateway.

With the **Back button** you can go back to the “Ethernet” submenu and, repeatedly pressing it, to **Normal display**.

15.2.5 Setting the standard gateway

Access to this function is possible only if manual IP address assignment has been selected (chap. 15.2.1)

Path: **Normal display**    **Settings**   **Ethernet**     **Standard gateway**

Press the **OK button** to enable the setting.

The standard gateway entry is done in four steps, corresponding to the number sections: (1).(2).(3).(4)

Principle of entry:

- Use the **OK button** to select the desired section of the standard gateway 1/4, 2/4, 3/4, 4/4 in the upper display line
- Use the **Arrow buttons** to enter the value for the selected section of the standard gateway
- For details please refer to the description of the similar procedure in chap. 15.2.3 “Assigning the IP address”.

With the **arrow-down button** you can now change to the assign the DNS server address.

With the **Back button** you can go back to the “Ethernet” submenu and, repeatedly pressing it, to **Normal display**.

15.2.6 Assigning the DNS server address

Access to this function is possible if manual IP address assignment (chap. 15.2.1) or manual DNS server address assignment (chap. 15.2.2) has been selected.

With manual IP address assignment:

Path: **Normal display**    **Settings**   **Ethernet**      **DNS server address**

With manual DNS server address assignment:

Path: **Normal display**    **Settings**   **Ethernet**    **DNS server address**

Press the **OK button** to enable the setting.

The DNS server address entry is done in four steps, corresponding to the number sections: (1).(2).(3).(4)

Principle of entry:

- Use the **OK button** to select the desired section of the DNS server address 1/4, 2/4, 3/4, 4/4 in the upper display line
- Use the **Arrow buttons** to enter the value for the selected section of the DNS server address
- For details please refer to the description of the similar procedure in chap. 15.2.3 “Assigning the IP address”.

With the **Back button** you can go back to the “**Ethernet**” submenu and, repeatedly pressing it, to **Normal display**.

16. Access codes (option “Door access system” for UF V 500 and UF V 700)

Chambers with the “Door access system” option are equipped with an electronic access control via NumPad, which, in connection with the electromechanical door locking, enables personalized access control.

16.1 Assigning the access codes

You can assign up to 20 access codes as four-digit number combinations.

Except "0000" (no code) all number combinations are allowed.

As long as no access code has been assigned (all 20 access codes set to “0000”, factory setting), the door can be opened directly with the “Open” pushbutton.

Once at least one access code has been assigned, the chamber door can no longer be opened without entering the code.

Required access level: “Admin”.

Path: **Normal display**    **Settings**      **Door access code**  **Code 1 door**

Press the **OK button** to enable the setting.

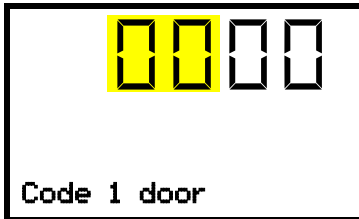

Function “Code 1 door”: Assigning the first access code.
The left two digits are flashing. Enter the desired numbers with the **arrow buttons**.
Confirm the setting with the **OK button**.

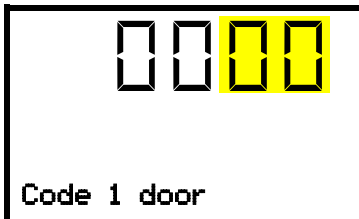

Function “Code 1 door”: Assigning the first access code.
The right two digits are flashing. Enter the desired numbers with the **arrow buttons**.
Confirm the setting with the **OK button**.

With the **arrow-down button** you can now change to the enter the next access code.

With the **Back button** you can go back to the “**Door access code**” submenu and, repeatedly pressing it, to **Normal display**.



Keep the access code well in mind.
Once an access code has been assigned, the chamber door can no longer be opened without entering the correct code.
The access level required to assign or modify an Access code is “Admin”.

16.2 Opening the chamber door with the access code

Once at least one access code has been assigned, it is required to open the chamber door.

Enter the four digits of the access code directly on the NumPad. Enter the digits quickly one after the other. If the input is too slow (> 5 seconds pause), the display changes again to the input of the first digit

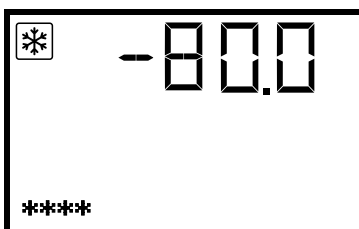

Normal display during the entry of an access code
(four digits entered)

After the access code has been entered completely and correctly, a confirmation will appear on the controller display:

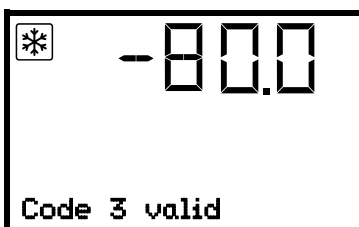

Normal display following the entry of a valid access code
(example: code no. 3).

The door can now be opened within 5 seconds with the push-button “OPEN”.

If you wait too long after entering the code (> 5 seconds pause), it is required to enter the code again.

The entry of the correct access code is noted in the event list: “Access code 3 valid”.

If an invalid number combination has been entered, a corresponding message appears

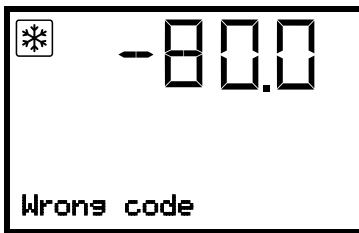

Normal display after incorrect entry of the access code

The entry attempt is noted in the event list: "Access code invalid".

Enter a valid access code.

If you press the "OPEN" pushbutton without having entered the access code, a prompt to enter an access code appears briefly on the controller display:

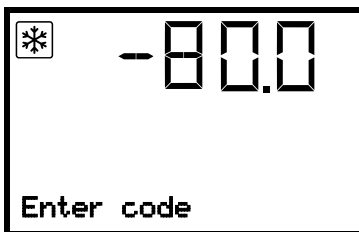

Normal display with prompt to enter an access code

17. Data recorder

An internal data recorder saves chamber data and events in three data sets.

With the export function "Export recorder data" (chap. 18.3) you can save the three data sets via the USB interface to USB stick. They are issued in the selected language as a spreadsheet with the file extension ".csv" and can be further processed in the desired program. The data is unencrypted. Always the entire data memory is read out.

17.1 Recorded data

All data is given out in tabular form. The headlines of the values "number", "date", and "time" are given out in the selected language, all other information in English.

- **Chamber data for the user "DL1"**

Tabular representation of the actual temperature value and temperature set-point together with the date and time, according to the set storage rate (chap. 17.3). Temperature values are always given out in °C.

- **Chamber data for BINDER Service "DL2"**

This data is intended for use by BINDER Service. The storage rate is fix (1 minute). Temperature values are always given out in °C.

- **Event list**

Messages regarding the controller and data memory as well as the alarm messages together with the date and time:

- Firmware update done
- "New config (USB)": New configuration uploaded via USB
- "Data recorder cleared": Data recorder and event list deleted via setup program
- Other event messages according to existing alarms
- The moment of switching the alarm state on and off is indicated under "On/Off".

17.2 Storage capacity

The storage capacity of the data recorder depends on the number of entries.

- DL1 = 110.000 entries (equaling 76 days with a storage rate of 1 minute, setting see chap. 17.3)
- DL2 = 27.000 entries (equaling 18 days with a fix storage rate of 1 minute)
- Event list: 200 events

The shorter the set storage rate, the closer are the stored measuring points, the more precise, but also shorter is the documented period.

Once the storage capacity of the data recorder is reached, overwriting of the oldest values begins

17.3 Setting the storage rate for the “DL1” recorder data

Required access level: “Admin”.

Path: **Normal display**    **Settings**    **Data recorder**  **Storage interval**

Press the **OK button** to enable the setting.

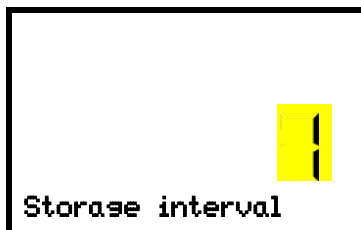

Function “Storage interval”.

The current setting flashes. Use the **arrow buttons** to enter the desired storage interval. Setting range: 1 minute to 60 minutes. Factory setting: 1 minute.

Press the **OK button** to confirm the setting.

With the **Back button** you can go back to the “**Data recorder**” submenu and, repeatedly pressing it, to **Normal display**.

17.4 Deleting the data recorder

When importing a configuration via USB stick (chap. 18.2) and when loading a new firmware version by BINDER service, the entire data memory is deleted.

BINDER service can also install the configuration by means of a setup program without deleting the data.

Regardless of this, BINDER Service can delete the data via a setup program.

Loading a new configuration via USB stick leads to deleting the data recorder.

	NOTICE
	<p>Danger of information loss when loading a new configuration via USB stick.</p> <p>Data loss.</p> <p>➤ Backup data before loading a new configuration via USB stick.</p>

18. USB-Menu: Data transfer via USB interface

A USB interface for data transfer via USB stick is located in the door lock and controller housing (the second micro USB interface is only used by the manufacturer).

The controller offers an import function and three export functions through the USB interface:

Import function (chap. 18.2):

- Configuration data in file "KONF380.set"

Export functions (chap. 18.3):

- Configuration data in file "KONF380.set"
- Recorder data
 - DL1 (chamber data for the user): "DL1_[MAC address of the chamber].csv"
 - DL2 (chamber data for BINDER Service): "DL2_[MAC address of the chamber].csv"
 - Event list: "EvList_[MAC address of the chamber].csv"

For detailed information on the file content see chap. 17.1.

- Service data

The "Service" folder is created on the USB stick and can be sent to BINDER Service. In addition to the configuration and recorder data, it contains further service-relevant information.

18.1 Connecting the USB stick

Connect the USB stick to the interface located in the triangular instrument panel.



Connect only USB sticks to the USB interface.

After inserting the USB stick, the initial function "Import configuration" is displayed.

As long as the USB stick is connected, only the functions for data transfer are available. Other controller functions are only available after removing the USB stick.

18.2 Import function

Required access level: "Admin".



Function "Import configuration".

To import configuration data from the USB stick, press the **OK button**.

With the **arrow-down button** you can now change to the setting of the "Export configuration" function.

18.3 Export functions

Required access level: any user



Function "Export configuration".

To write the configuration data from the controller to the USB stick, press the **OK button**.

With the **arrow-down button** you can now change to the next function.



Function "Export recorder data".

To write the recorder data from the controller to the USB stick, press the **OK button**.

With the **arrow-down button** you can now change to the next function.



Function "Export service data".

To write the chamber data from the controller to the USB stick, press the **OK button**.

18.4 Ongoing data transfer

A moving arrow symbol indicates the progress of the data transfer.

Example:



Data recording is running.

Attention! Danger of data loss! Do not disconnect the USB stick from the device during ongoing data transfer!

After successful transfer, the controller shows again the initial function "Import configuration".

18.5 Error during data transmission

In the event of an error, the message ERR (error) is displayed.



Read error (example).

18.6 Removing the USB stick

Logging off the USB stick is not possible / required.

Be sure that no data recording is running (chap. 18.4).

After removing the USB stick, the controller is back in the same menu as before when connecting the USB stick.

19. Battery management system (option “battery-buffered alarm system”)

This controller menu is available only with chambers equipped with the “battery-buffered alarm system” option. You can check whether the optional battery is present and which is its current charging state. These are pure display functions without any setting options.

19.1 Battery operation

This menu shows whether the chamber voltage is supplied by the battery.

- Display “YES”: Battery operation (during power failure)
- Display “NO”: Battery is charging, external power connection available

If no battery is detected (battery is missing, completely empty (< 3V), or defective, on line power the alarm message “Battery defective” is emitted (chap. 14.4.5).

Required access level: “User”.

Path: **Normal display**   **Chamber info**     **Battery management**  **Battery operation**



Display “Battery operation”.
 YES = Battery operation, no power connection available
 NO = Battery charging, external power supply

With the **arrow-down button** you can now change to the function “Charging voltage”.

With the **Back button** you can go back to the “**Battery management**” submenu and, repeatedly pressing it, to **Normal display**.

19.2 Charging voltage

This menu shows the battery's current charging voltage. The correct voltage is > 12 V.

As soon as the charging voltage falls below the limit value of 12 V, the information message "Low battery voltage" is emitted. This happens on battery power and on line power (chap. 14.4.5).

Required access level: "User".

Path: **Normal display**   **Chamber info**     **Battery management**   **Charging voltage**



Display of the battery's current charging voltage.

With the **arrow-up button** you can change to the function "Battery operation".

With the **Back button** you can go back to the "**Battery management**" submenu and, repeatedly pressing it, to **Normal display**.

20. Setting and activating the service setpoint

To set a lower setpoint value for test purposes or for adjustment, you can enter and activate a service setpoint. This setting is outside the control range and is not intended for normal operation.

Once the service setpoint has been activated, the standard temperature setpoint will have no effect. Only after deactivating the service setpoint, the chamber will equilibrate again to the standard temperature setpoint.

20.1 Setting the service setpoint

Required access level: "Admin".

Path: **Normal display**    **Settings**     **Various**     **Service setpoint**

Press the **OK button** to enable the setting.

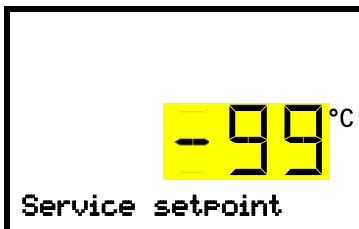

Setting the service setpoint

The current setting flashes. Use the **arrow buttons** to enter the desired value. Entry range: +20 °C up to -99 °C. Factory setting: -99 °C.

Confirm the setting with the **OK button**.

With the **arrow-up button** you can go to the tolerance range alarm setting (chap. 13.3).

With the **Back button** you can go back to the "**Various**" submenu and, repeatedly pressing it, to **Normal display**.

20.2 Activating the service setpoint

Required access level: "User".

Path: **Normal display**  **Setpoints**   **Functions on/off**    **Service setpoint on/off**

With optional CO₂ emergency cooling:

Path: **Normal display**  **Setpoints**    **Functions on/off**    **Service setpoint on/off**

Press the **OK button** to enable the setting.

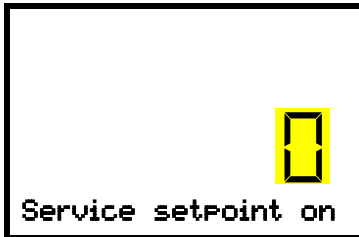

Setting function 3 "Service setpoint on/off".

The current setting flashes. Use the **arrow buttons** to select between 1 (Service setpoint active) and 0 (Service setpoint not active).

Confirm the setting with the **OK button**.

With the **Back button** you can go back to the "**Functions on/off**" submenu and, repeatedly pressing it, to **Normal display**.

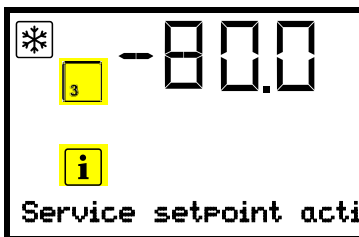

Normal display with the information message "Service setpoint active".

The service setpoint will remain active until manually deactivating function 3 "Service setpoint on/off".

21. CO₂ emergency cooling (option)

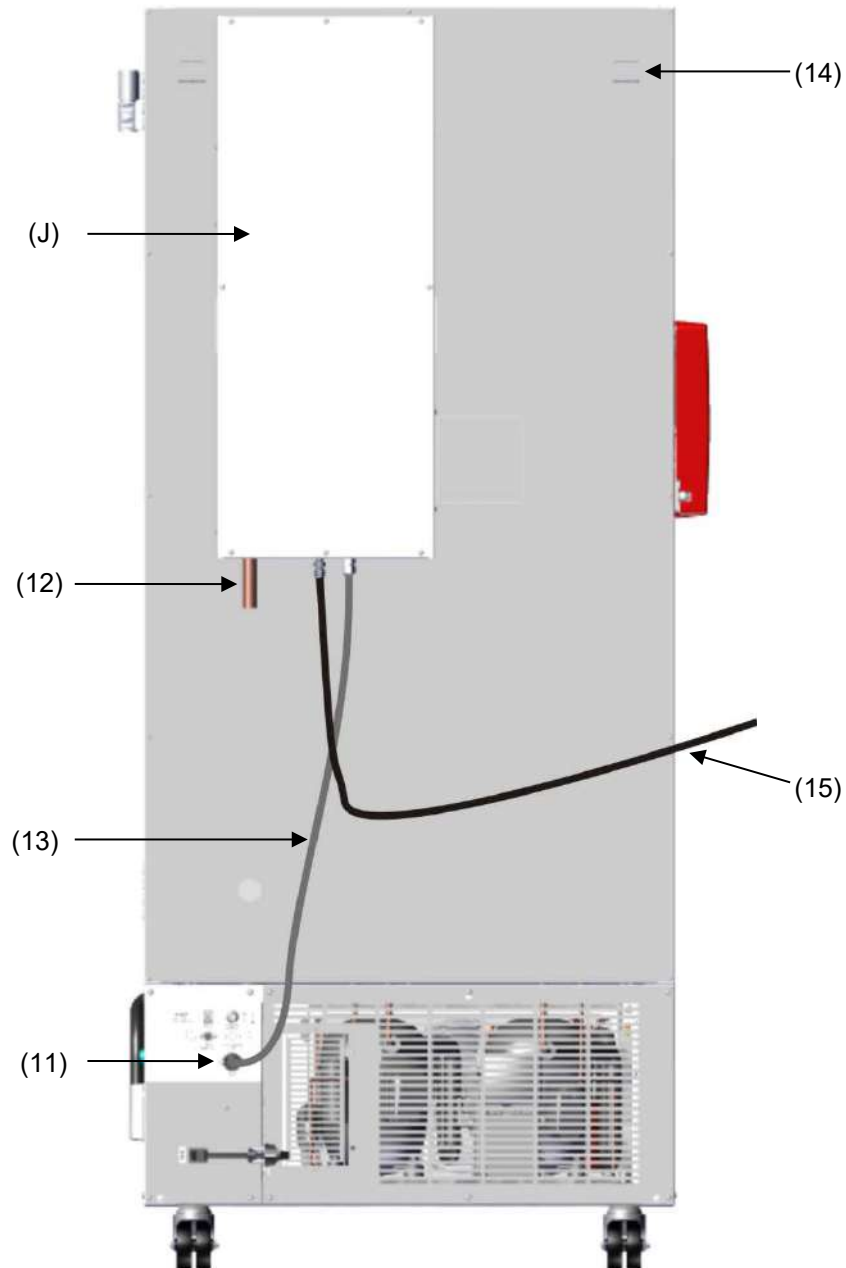

Figure 25: Rear view UF V with CO₂ emergency cooling system

- (J) CO₂ emergency cooling
- (11) Connection socket for the electrical connection of the CO₂ emergency cooling
- (12) CO₂ discharge outlet to connect a discharge hose
- (13) Cable to connection socket (11) for the electrical connection of the CO₂ emergency cooling
- (14) Pressure compensation opening (visible from the inside). Here CO₂ will also escape.
- (15) Gas hose to connect the pressurized CO₂ cylinders

Control and temperature measurement of the chamber controller are used for the CO₂ emergency cooling; therefore this option cannot be used for ultra-low temperature freezers from other manufacturers



The optional CO₂ emergency cooling is intended only for the use with a BINDER ultra-low temperature freezer UF V.

The CO₂ emergency cooling offers additional refrigeration when the inner chamber temperature increased up to the pre-set emergency cooling temperature. This may become necessary, following introduction of a heat load, in case of a power failure or failure of the cooling system.

Principle: CO₂ is taken from the gas bottle in liquid form and introduced into the freezer UF V when required. There the gas expands and cools off intensely, forming a mixture of CO₂ gas and CO₂ snow. The CO₂ snow provides the required cooling capacity through the transition into the gaseous state.

The emergency cooling system is integrated into the safety chain of the chamber. In case of power failure, rechargeable batteries supply the CO₂ emergency cooling power supply, during normal operation power is supplied by a power supply unit 24V DC. The rechargeable battery is designed for an interruption of the external power supply of 72 hours maximum. Therefore, if pressurized CO₂ cylinders are available in sufficient quantity, functioning of the CO₂ emergency cooling should last through a week-end.

You can set the CO₂ emergency cooling system between -40 °C / -40 °F and -70 °C / -94 °F. In order to ensure an emergency cooling time as long as possible with a given CO₂ stock, select the highest possible emergency cooling temperature.

The optional CO₂ emergency cooling system is also available as a retrofit kit. Please contact BINDER Service.

The optional CO₂ emergency cooling system, factory mounted, includes the option Battery-buffered alarm system (Art. no. 8012-1910).

Note: When installing the CO₂ emergency cooling system as a retrofit kit, the freezer must first be equipped with the battery-buffered alarm system. This option must be present on the device, otherwise it is not possible to install the CO₂ emergency cooling system as a retrofit set.



The upper 28 mm access port (6a) on the chamber rear serves to connect the CO₂ emergency cooling.



When mounting the optional CO₂ emergency cooling, the GS mark and the cUL mark are no longer valid.

21.1 Connecting and exchanging the pressurized CO₂ cylinder



The CO₂ emergency cooling system works exclusively with liquid CO₂. Use CO₂ dip tube cylinders with a W21.8 x 1 ¼ inch safety valve connection. The maximum ambient temperature for the cylinder must not exceed 35 °C / 95 °F. The dip tube inside enables almost complete liquid withdrawal. CO₂ dip tube cylinders must stand upright during withdrawal.

Note regarding the installation site of the gas cylinder:

The cooling power decreases with increasing temperature of the liquid CO₂. Do not install the gas cylinder in the exhaust airflow of the UF V.



The supplied gas hose (15) is already connected with the CO₂ emergency cooling system. The user shall not remove this connection. When replacing the gas hose is required, please contact BINDER Service. To connect the pressurized CO₂ cylinder, connect the free end of the gas hose to the gas cylinder (wrench size A/F 30 mm / 1.2 in). Then open the valve of the gas cylinder.

Before changing the gas cylinder, first close the valve of the empty gas cylinder. Perform a test run of the CO₂ emergency cooling to reduce the CO₂ pressure in the emergency cooling system. Only then unscrew the gas hose.





After connecting the gas cylinder, check the hose connection with a soap solution for gas leaks. The hose connection must be tight

The valve of the gas cylinder **always** must be closed before screwing on or unscrewing the gas hose

	 WARNING
	<p>Risk of injury through sudden release of the stored pressure energy when opening the cylinder valve of a not connected cylinder.</p> <p>Injuries.</p> <ul style="list-style-type: none"> ➤ Close the gas cylinder valve before connecting or removing the gas hose.

Secure the pressurized gas cylinder against falling and other mechanical damage.

	 WARNING
	<p>Risk of injury through sudden release of the stored pressure energy when the valve safety is torn off.</p> <p>Injuries.</p> <ul style="list-style-type: none"> ➤ Secure gas cylinders against falling (chaining). ➤ Transport gas cylinders with a cylinder cart.



General information for safe handling of pressurized CO₂ cylinder:

- Open the gas cylinder valve slowly to avoid pressure surges.
- Secure gas cylinders during storage and use against falling (chaining).
- Transport gas cylinders with a cylinder cart, do not carry, roll, or throw them.
- Always close the valve even with apparently empty cylinders; screw on the cap when not in use. Return gas cylinders with the valve closed.
- Do not open gas cylinders by force. Mark them when damaged.
- Protect gas cylinders against fire, e.g. do not store together with flammable liquids.
- Observe relevant regulations for dealing with pressurized CO₂ cylinder.

Information for the operator concerning requirements and regulations for use of pressurized gas cylinders in the laboratory (not exhaustive):

A **storage** of pressurized gas cylinder (stockholding, no connection for emptying, storing for later use or for supply to others) in a laboratory without a storage cabinet is generally prohibited. The requirements for fire-protected pressurized gas cylinder cabinets are described in DIN EN 14470-2:2006.



Provisioning (reserve cylinders connected to the points intended for emptying or provided for imminent connection) and **using** (provisioning, operating, emptying) of pressurized gas cylinders may also take place outside storage cabinets or storage rooms, provided that the safety requirements are met. This applies to the operation of the CO₂ emergency cooling system.

- Observe all relevant local and national regulations, in particular the requirements for provisioning / emptying the pressurized gas cylinders (for Germany: Technical Regulations TRBS 3145 / 725).
- If there are more than 6 cylinders in the laboratory, they must be placed in cylinder cabinets, special installation rooms or outdoors. After work (UF V turned off) store the cylinders in a safe storage location.
- Perform leakage tests
- Fire extinguishers must be available in order to protect the gas cylinders against heating in case of fire

- Make sure that operating instructions on the connection and exchange of the pressurized gas cylinders are attached in the vicinity of the pressurized gas cylinders. The instructions shall contain all required safety-related information in an intelligible form.
- Laboratories in which compressed gas cylinders are installed must be labeled with the warning sign W019 “Warning of gas cylinders”.
- In areas with increased risk of fire, if possible set up gas cylinders outside the rooms and install fix tubing.



Carbon dioxide (CO₂) in high concentrations (> 4 Vol.-%) is hazardous to health. It is colorless and almost odorless and therefore practically imperceptible. Escaping CO₂ gas is heavier than air and accumulates at the ground or possibly in lower-lying parts of the building. There is danger of suffocation and poisoning. Hazards due to uncontrolled gas release must be effectively avoided.

	 DANGER
	<p>Danger of suffocation and poisoning by high concentration of CO₂ (> 4 Vol.-%). Death by suffocation.</p> <ul style="list-style-type: none"> ➤ Operate the CO₂ emergency cooling only in a well-ventilated room. ➤ Ensure technical ventilation measures. Install a suitable conduct at the CO₂ discharge outlet of the emergency cooling system. ➤ Observe the relevant regulations for handling CO₂. ➤ Close the CO₂ supply when decommissioning the chamber.

When installing pressurized CO₂ cylinders, consider the **structure of the building**.



- The installation site must be in a well-ventilated area (**natural ventilation**). For rooms with a with a floor area of ≤ 12 m² with solid walls without openings on all sides there are further regulations (max. two 14-liter CO₂ cylinders, Label “suffocation” and prohibition to close the door after entering).
- The installation site must be technically ventilated (**technical ventilation**) with a CO₂ alarm system (**gas warning device**)

We strongly recommend continuous monitoring of the CO₂ concentration in the ambient air of the CO₂ emergency cooling. It must be permanently ensured that the **occupational exposure limit OEL** (formerly maximum permitted workplace concentration) of 0.5 Vol.-% CO₂ is not exceeded.

21.2 Operating the CO₂ emergency cooling system

When operating the CO₂ emergency cooling system, the freezer’s interior is flooded with CO₂. CO₂ in high concentrations (> 4 vol.-%) is hazardous to health. It is colorless and almost odorless and therefore practically imperceptible. Operate the CO₂ emergency cooling system only in a well-ventilated room. Released CO₂ gas muss must be safely led out via good room ventilation or a suitable connection to an exhaust system and through a conduct at the CO₂ discharge outlet (12) on the rear of the emergency cooling system. Observe the occupational exposure limit for CO₂ set by the national authorities. We recommend installing a CO₂ warning system.

Even when CO₂ or systems operated with CO₂ are handled carefully and appropriately, a residual risk remains, which can lead to life-threatening situations under certain circumstances. Therefore, we strongly recommend continuous monitoring of CO₂ concentration in the ambient air of CO₂ emergency cooling. It must be ensured permanently that the maximum permissible occupational exposure limit for CO₂ (0.5 vol - % CO₂ for Germany) is not exceeded.

	 DANGER
<p>Danger of suffocation and poisoning by high concentration of CO₂ (> 4 Vol.-%). Death by suffocation.</p> <ul style="list-style-type: none"> ➤ Operate the CO₂ emergency cooling only in a well-ventilated room. ➤ Ensure technical ventilation measures. Install a suitable conduct at the CO₂ discharge outlet of the emergency cooling system. ➤ Observe the relevant regulations for handling CO₂. ➤ Close the CO₂ supply when decommissioning the chamber. 	

We recommend connecting an exhaust hose to the CO₂ discharge outlet (12) and to conduct it to the outside or to an exhaust system. Since the CO₂ emergency cooling system is also effective in case of a power failure, an uninterruptible power supply is recommended for the exhaust system.

The RD4 chamber controller measures and controls the temperature value inside the useable volume. Depending on the increase or decrease of temperature, the controller controls the CO₂ emergency cooling in standard operation and during power failure. As soon as the preselected emergency cooling temperature is reached inside the useable volume, the solenoid valve of the emergency cooling system opens, and liquid CO₂ from the pressurized CO₂ cylinder is injected at intervals into the useable volume. The liquid CO₂ expands until ambient pressure and evaporated into the useable volume. This results in cooling-down the useable volume to the pre-set emergency cooling temperature.

When opening the outer door, CO₂ injection is interrupted. This prevents potential cold burns / frostbite by inflowing CO₂ gas at manipulation inside the freezer.

	<p>After turning on the freezer, the CO₂ emergency cooling is deactivated until the CO₂ emergency cooling setpoint has been reached for the first time.</p>
---	---

When operating the CO₂ emergency cooling, the temperature distribution may deviate from the technical data valid at -80 °C (chap. 27.3).

Activating the CO₂ emergency cooling:

- Open the valve of the CO₂ gas cylinder
- Set the emergency cooling temperature at the controller (chap. 21.3.1)
- Activate the CO₂ emergency cooling at the controller (chap. 21.3.2)
- If desired, perform a test run (chap. 21.3.3).

21.3 Settings on the chamber controller

The following controller menus are available only with chambers equipped with the optional CO₂ emergency cooling.

21.3.1 Setting the CO₂ emergency cooling temperature setpoint

	<p>It is recommended to set the CO₂ emergency cooling setpoint by at least 10 °C above the chamber temperature setpoint and above the tolerance range alarm limit.</p>
---	---

Required access level: "User".

Path: **Normal display**  **Setpoints**   **CO₂ emergency cooling**

Press the **OK button** to enable the setting.

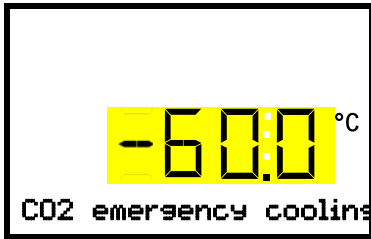

Setting the CO₂ emergency cooling temperature setpoint
The current setting flashes. Enter the desired set-point with the **arrow buttons**. **Setting range:** -30 °C up to -70 °C
Confirm the entry with the **OK button**.

With the **Back button** you can go back to the “**Setpoints**” submenu and, repeatedly pressing it, to **Normal display**.

21.3.2 Activating the CO₂ emergency cooling

Required access level: “User”.

Path: **Normal display**  **Setpoints**    **Functions on/off**  **CO₂ emer.cooling on/off**

Press the **OK button** to enable the setting.

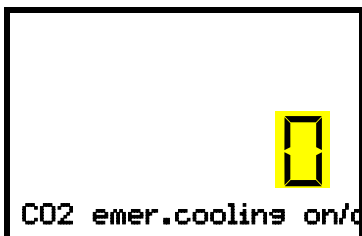

Setting function 1 “CO₂ emer.cooling on/off”.
The current setting flashes. Use the **arrow buttons** to select between 0 (deactivated emergency cooling) and 1 (activated emergency cooling).
Confirm the setting with the **OK button**.

With the **Back button** you can go back to the “**Functions on/off**” submenu and, repeatedly pressing it, to **Normal display**.

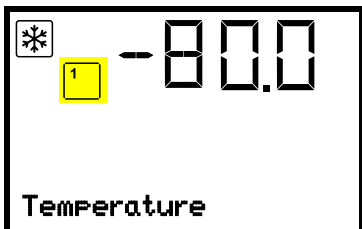

Normal display with activated emergency cooling

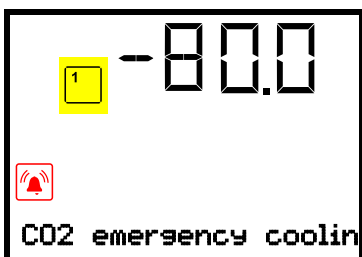

Normal display with running emergency cooling, showing the alarm message “CO₂ emergency cooling”



The valve of the CO₂ gas cylinder must be open, otherwise pressure alarm will occur.

Inactivating the CO₂ emergency cooling

1. Inactivate the CO₂ emergency cooling at the controller.
2. Close the valve of the CO₂ gas cylinder.

21.3.3 Test run of the CO₂ emergency cooling

You can carry out a test run of the CO₂ emergency cooling at any time, even if the CO₂ emergency cooling is not activated.

The test run of the CO₂ emergency cooling runs after start until it is deactivated again.

Required access level: "User".

Path: **Normal display**  **Setpoints**    **Functions on/off**   **CO₂ cooling test on/off**

Press the **OK button** to enable the setting.

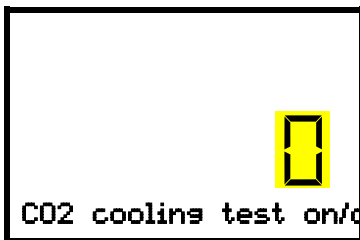

Setting function 2 "CO₂ cooling test on/off".
The current setting flashes. Use the **arrow buttons** to select between 0 (deactivated test run) and 1 (activated test run).
Confirm the setting with the **OK button**.

With the **Back button** you can go back to the "**Functions on/off**" submenu and, repeatedly pressing it, to **Normal display**.

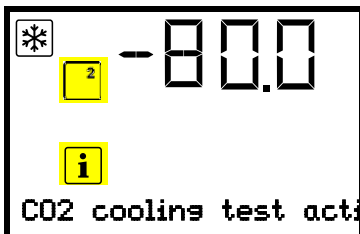

Normal display during test run of the CO₂ emergency cooling, showing the information message "CO₂ cooling test active"

After performing a test run, deactivate the setting again.

22. Data monitoring and recording

22.1 Ethernet interface

The chamber is regularly equipped with an Ethernet interface (8) that can connect the BINDER APT-COM™ 4 Multi Management Software (option). The MAC Address is indicated in the “Ethernet” controller menu (chap. 15.1.1).

22.2 APT-COM™ 4 Multi Management Software (option)

You can connect the BINDER APT-COM™ 4 Multi Management Software via the chamber’s Ethernet interface (8).

The APT-COM™ System permits the networking of up to 100 chambers and connection to a PC for controlling and programming, as well as recording and representing temperature data. The actual temperature value is given at adjustable intervals. Programming can be performed graphically via PC. For further information please refer to the APT-COM™ 4 operating manual.

22.3 Analog output for temperature (option)

With this option the freezer is equipped with an analog output 4-20 mA for temperature. This output permits transmitting data to external data registration systems or devices.

The connection is realized as a DIN socket (10) in the rear connection panel as follows:



ANALOG OUTPUT 4-20 mA DC

PIN 1: Temperature –
PIN 2: Temperature +

Temperature range: +40 °C / 104°F to -100 °C / -148°F

A suitable DIN plug is enclosed.

Figure 26: Pin allocation of DIN socket (10) for option analog output

23. Chamber inventory: Storage rack systems and cryo boxes (option)

23.1 Storage rack systems with or without cryo boxes

For optimum use of the available space of the freezer compartments, the following racks are available:

- Side access racks, aluminum or stainless steel
- Sliding drawer racks, stainless steel



Side access racks with cryo boxes



Sliding drawer racks with smoothly running drawers and cryo boxes

Figure 27: Storage rack systems and cryo boxes

All racks are available in two different heights:

- 280 mm / 11 in height for 5 standard cryo boxes (50 mm / 2 in) stacked
- 330 mm / 13 in height for 6 standard cryo boxes (50 mm / 2 in) stacked

Racks are optionally empty or filled with standard cryo boxes

The cardboard cryo boxes come with a divider (9 x 9 grid for 81 samples).

Rack height	No. of sections for cryo boxes (height x depth)	Cryo boxes	Side access rack, stainless steel Art. no.	Side access rack, aluminum Art. no.	Sliding drawer, stainless steel Art. no.
280 mm / 11 in	5 x 4	empty	6017-0043	6017-0041	6017-0045
280 mm / 11 in	5 x 4	with boxes	6017-0044	6017-0042	6017-0046
330 mm / 13 in	6 x 4	empty	6017-0049	6017-0047	6017-0051
330 mm / 13 in	6 x 4	with boxes	6017-0050	6017-0048	6017-0052

23.2 Cryo boxes

Set of 36 standard cryo boxes, cardboard, white, height 50 mm / 2 in with 9 x 9 grid







Figure 28: Cryo boxes with dividers, Art. no. 6017-0053

24. Cleaning and decontamination

Clean the chamber after each use to avoid potential corrosion damage by ingredients of the charging material.

Prior to renewed startup, allow the chamber to completely dry after all cleaning and decontamination measures.

During operation: Wipe only the outer surfaces with a humid cloth and then dry it thoroughly

	 DANGER
	<p>Electrical hazard by water entering the chamber. Deadly electric shock.</p>
	<p>Ø Do NOT spill water or cleaning agents over the inner and outer chamber surfaces.</p>
	<p>Ø Do NOT put ANY cleaning aids (cloth or brush) into slots or openings on the chamber.</p>
	<p>Ø Before cleaning, turn off the chamber at the main power switch and disconnect the power plug.</p>
	<p>Ø Completely dry the chamber before turning it on again.</p>

24.1 Cleaning

Disconnect the chamber from the power supply before cleaning. Disconnect the power plug.

	<p>The interior of the chamber must be kept clean. Thoroughly remove any residues of the charging material.</p>
---	---

Wipe the surfaces with a moistened towel. In addition, you can use the following cleaning agents (apply on a cloth):

<p>Exterior surfaces, door lock and controller housing with controller panel, interior (stainless steel) shelves, door gaskets</p>	<p>Standard commercial cleaning detergents free from acid or halides. Alcohol based solutions. We recommend using the neutral cleaning agent Art. No. 1002-0016.</p>
<p>Instrument panel</p>	<p>Standard commercial cleaning detergents free from acid or halides. We recommend using the neutral cleaning agent Art. No. 1002-0016.</p>
<p>Zinc coated hinge parts rear chamber wall</p>	<p>Standard commercial cleaning detergents free from acid or halides. Do NOT use a neutral cleaning agent on zinc coated surfaces.</p>

Do not use cleaning agents that may cause a hazard due to reaction with components of the device or the charging material. If there is doubt regarding the suitability of cleaning products, please contact BINDER service.

	<p>We recommend using the neutral cleaning agent Art. No. 1002-0016 for a thorough cleaning. Any corrosive damage that may arise following use of other cleaning agents is excluded from liability by BINDER GmbH.</p> <p>Any corrosive damage caused by a lack of cleaning, is excluded from liability by BINDER GmbH.</p>
---	---

	NOTICE
	<p>Danger of corrosion by using unsuitable cleaners. Damage to the chamber.</p> <ul style="list-style-type: none"> ∅ Do NOT use acidic or chlorine cleaning detergents. ∅ Do NOT use a neutral cleaning agent on other kind of surfaces e.g., the zinc coated hinge parts or the rear chamber wall.

	<p>For surface protection, perform cleaning as quickly as possible. After cleaning completely remove cleaning agents from the surfaces with a moistened towel. Let the chamber dry.</p>
--	---

	<p>Soapsuds may contain chlorides and must therefore NOT be used for cleaning.</p>
--	--

	DANGER
	<p>Risk of locking in a person. Death from suffocation or freezing.</p> <ul style="list-style-type: none"> ➤ Before closing doors, make sure that nobody is inside. ➤ Pull the power plug before entering the interior (e.g. for cleaning purposes).

	<p>With every cleaning method, always use adequate personal safety controls.</p>
--	--

Following cleaning, leave the chamber door open or remove the access port plugs.

	<p>The neutral cleaning agent may cause health problems in contact with skin and if ingested. Follow the operating instructions and safety hints labeled on the bottle of the neutral cleaning agent.</p>
--	---

Recommended precautions: To protect the eyes use sealed protective goggles. Wear gloves. Suitable protective gloves with full contact: butyl or nitrile rubber, penetration time >480 minutes.

	CAUTION
	<p>Danger of chemical burns through contact with skin or ingestion of the neutral cleaning agent. Skin and eye damage. Environmental damage.</p> <ul style="list-style-type: none"> ∅ Do not ingest the neutral cleaning agent. Keep it away from food and beverages. ∅ Do NOT empty the neutral cleaning agent into drains. ➤ Wear protective gloves and goggles. ➤ Avoid skin contact with the neutral cleaning agent.

	<p>The door handle, door hinges and the locking counterpart must be cleaned at least once a year</p>
--	--

24.2 Decontamination / chemical disinfection

The operator must ensure that proper decontamination is performed in case a contamination of the chamber by hazardous substances has occurred.

Disconnect the chamber from the power supply prior to chemical decontamination. Disconnect the power plug.

Do not use decontamination agents that may cause a hazard due to reaction with components of the device or the charging material. If there is doubt regarding the suitability of cleaning products, please contact BINDER service.



You can use the following disinfectants:

	For chemical disinfection, we recommend using the disinfectant spray Art. No. 1002-0022. Any corrosive damage that may arise following use of other disinfectants is excluded from liability by BINDER GmbH.
---	--

	With every decontamination method, always use adequate personal safety controls.
---	--

	In case of eye contact, the disinfectant spray may cause eye damage due to chemical burns. Follow the operating instructions and safety hints labeled on the bottle of the disinfectant spray.
---	--

Recommended precautions: To protect the eyes use sealed protective goggles.

	<div style="background-color: yellow; text-align: center; padding: 5px;"> CAUTION</div> <p>Danger of chemical burns through eye contact with the disinfectant spray. Eye damage. Environmental damage.</p> <ul style="list-style-type: none"> ⊘ Do NOT empty the disinfectant spray into drains. ➤ Wear protective goggles.
---	--

	After using the disinfectant spray, allow the chamber to dry thoroughly, and aerate it sufficiently.
---	--

Alternatively, you can use the following disinfectants (apply on a cloth):

Interior (stainless steel), compartment doors	Standard commercial surface disinfectants free from acid or halides (not dripping). Alcohol based solutions.
Outer door gasket and inner door gasket (silicon)	Alcohol based solutions

	Following use, completely remove any disinfectant with a sterile moistened towel from the surfaces.
---	---

Before start-up, the chamber must be absolutely dry and ventilated, as explosive gases may form during the decontamination process.

25. Maintenance and service, service, troubleshooting, repair, testing

25.1 General information, personnel qualification

- **Maintenance**

See chap. 25.4.

- **Maintenance work by the customer**

This work must be carried out regularly by the operating personnel to maintain the chamber function (chap. 25.2).

For personnel requirements please refer to chap. 1.1.

- **Simple troubleshooting**

Chap. 25.3 describes troubleshooting by operating personnel. It does not require technical intervention into the chamber, nor disassembly of chamber parts.

For personnel requirements please refer to chap. 1.1.

- **Detailed troubleshooting**

If errors cannot be identified with simple troubleshooting, further troubleshooting must be performed by BINDER Service or by BINDER qualified service partners or technicians, in accordance with the description in the Service Manual.

For personnel requirements please refer to the Service Manual.

- **Repair**

Repair of the chamber can be performed by BINDER Service or by BINDER qualified service partners or technicians, in accordance with the description in the Service Manual.

After maintenance, the chamber must be tested prior to resuming operation.

- **Electrical testing**

To prevent the risk of electrical shock from the electrical equipment of the chamber, an annual repeat inspection as well as a test prior to initial startup and prior to resuming operation after maintenance or repair, are required. This test must meet the requirements of the competent public authorities. We recommend testing under DIN VDE 0701-0702:2008 in accordance with the details in the Service Manual.

For personnel requirements please refer to the Service Manual

25.2 Maintenance work by the customer

25.2.1 Checking and cleaning / replacing the condenser air filter

The condenser air filter prevents accumulation of dust on the condenser. If the filter is blocked by dust this may cause decrease or failure of refrigeration.

Check the air filter visually for soiling every month. Especially with the alarm message "Condenser temp." (chap. 14.1) the filter may be soiled. You can rinse the filter and use it again.



Regularly check the filter visually for soiling.

The filter is located behind the air filter flap (E) in the lower housing cover. You can easily take it out for cleaning or replacement.

- Unscrew the quick locking screws (E2) of the air filter flap (E) and remove the air filter flap
- Remove the condenser air filter (E1).
- Wash the condenser air filter with water and let it dry. If necessary, replace the filter (Art. no. 6014-0037).
- Insert the condenser air filter and mount the air filter flap. Mount the quick locking screws.

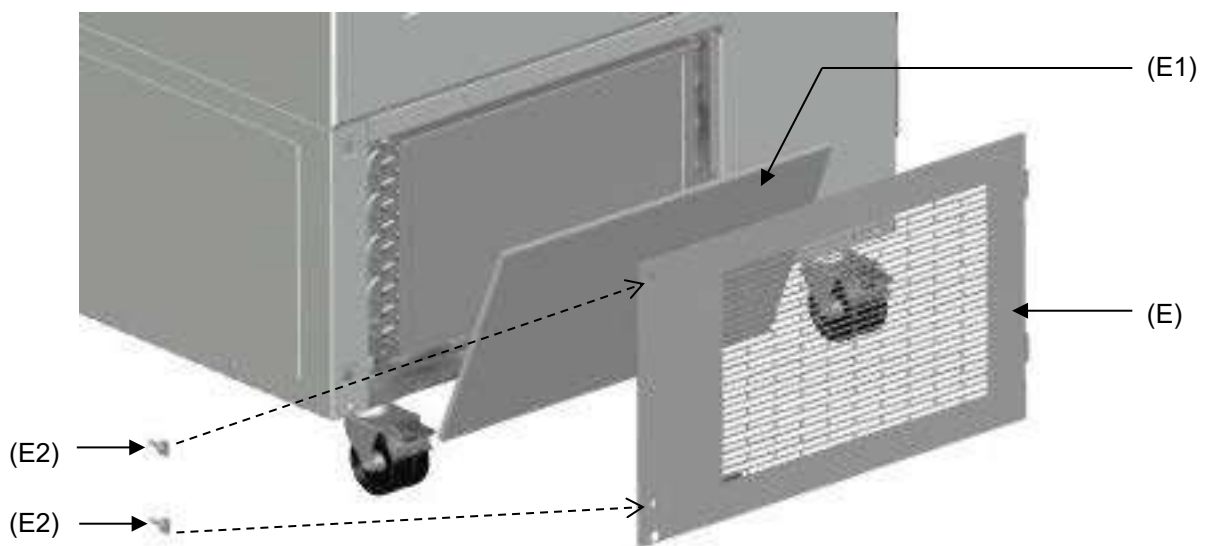

Figure 29: Removing the condenser air filter

(E) Air filter flap

(E1) Condenser air filter

(E2) Quick locking screws



Fix the condenser air filter and the air filter flap correctly following cleaning or replacement

25.2.2 Cleaning the condenser

Every 6 months remove by suction any visible dust on the condenser lamellas with a vacuum cleaner. If appropriate, blow through the lamellas with compressed air.

With an increased amount of dust in the ambient air, clean the condenser several times a year. In this case we recommend to weekly check the condenser lamellas (behind the air filter flap (E)). If soiling is visible, turn off the chamber and remove the dust by suction from the condenser lamellas.

25.2.3 De-icing and defrosting



We recommend for material that could be damage already by slight warming, to provide adequate storage facilities (e.g., in a second chamber / with liquid nitrogen).

Ice may form at the upper part of the chamber and on the inner doors. Excessive frost may lead to increasing the inner chamber temperature. Remove the frost on the doors with the ice scraper (part of the optionally available deicing kit).



Regularly (recommendation: every month) remove the frost on the doors with the ice scraper.

Note: If the door has not been opened for a longer period of time (more than 5 days), it is advisable to de-ice the door gaskets and the inner opening of the pressure compensation valve (I). After that, the door can be opened even after a short period of time without applying great force.

After an extended period of operation, defrosting may become necessary:

To defrost the entire chamber, proceed as follows:

- Turn off external protocol systems (option) if applicable.
- Place the stored material in another freezer or in a container refrigerated by dry ice or liquid carbon dioxide.
- Turn off the chamber at its main power switch (4) and disconnect it from the power supply.
- Open the outer door and all inner doors.
- Place absorbent towels on the bottom of the inner chamber or mount the optional drain well (chap. 2.5) and allow the frost to melt.



NOTICE

Risk of damage to the interior through scraping and piercing with a sharp instrument.

Damage to the chamber.

- ⊘ NEVER use tools with a sharp edge to remove the frost.
- Use the supplied ice scraper only.

- Wipe up the accumulated water with absorbent towels
- Let the interior of the freezer dry. Clean and decontaminate it as described in chap. 24



When taking the chamber into operation again, please follow the hints given in chap. 6.2.

- Connect the freezer to the power supply and turn it on with the main power switch (4).
- Operate the chamber for at least 9 hours. Then introduce the material into the freezer.
- Turn on external protocol systems (option) if applicable.

When defrosting, water may accumulate on the shelves and the bottom. Procedure to remove it:

- Carry the water from the freezer shelves and bottom with the wiper into the drain well (option, chap. 2.5).
- Then dry all inner chamber equipment with an absorbent towel.

25.2.4 Maintenance of the door lock

The door handle, door hinges and the locking counterpart must be cleaned at least once a year (chap. 24.1). After cleaning, lubricate the running surface of the handle and the locking counterpart with medical vaseline.

25.3 Simple troubleshooting

Defects and shortcomings can compromise the operational safety of the chamber and can lead to risks and damage to equipment and persons. If there is a technical fault or shortcoming, take the chamber out of operation and inform BINDER Service. If you are not sure whether there is a technical fault, proceed according to the following list. If you cannot clearly identify an error or there is a technical fault, please contact BINDER Service.





Only qualified service personnel authorized by BINDER must perform repair. Repaired chambers must comply with the BINDER quality standards.

Fault description	Possible cause	Required measures
General		
Chamber without function.	No power supply.	Check connection to power supply.
	Wrong voltage.	Check power supply for correct voltage (chap.4.5).
	Chamber fuse has responded.	Check chamber fuse and replace it if appropriate. If it responds again, contact BINDER service.
	Controller defective.	Contact BINDER service.
Alarm message "Door open"	Chamber door open.	Close chamber door.
Refrigerating performance		
No refrigerating performance after turning on the chamber. Alarm message "Safety controller"	Limit temperature reached.	Check setting of temperature set-point and of safety controller. If appropriate, select suitable limit value.
	Controller defective.	Contact BINDER service.
	Safety controller defective.	
	Semi-conductor relay defective.	
	Too much external heat load.	Reduce heat load

Fault description	Possible cause	Required measures
Refrigerating performance (continued)		
Chamber refrigerating permanently, set-point not held.	Semiconductor relay defective.	Contact BINDER service.
	Controller defective.	
	Controller not adjusted, or adjustment interval exceeded.	Calibrate and adjust controller.
	Door not shut tightly.	Check if doors are closed.
	Frost on door gasket.	Defrost the door gasket with the ice scraper.
	Door gasket defective.	Contact BINDER service.
	Door opened very frequently.	Open doors less frequently
	Place of installation too warm.	Select cooler place of installation or contact BINDER service.
	Introduction of too warm or too large amount of material.	Cool down material before introducing and / or load in smaller portions.
Alarm message "Temp. range"	Current actual temperature value outside the tolerance range.	Operation temporarily possible. Check the tolerance range settings. With other error messages remove the respective cause.
Alarm message "Inner temp. sensor"	Inner temperature sensor defective. Control continues using the safety controller temperature sensor	Operation temporarily possible. Contact BINDER service.
Alarm message "Safety control sensor"	Safety controller temperature sensor defective	Operation temporarily possible. Contact BINDER service.
Temperature display shows "- - - -" or "<-<-<" or ">->->" Messages alternating: Inner temp. sensor and Safety control sensor	Inner temperature sensor and safety controller temperature sensor defective. Refrigeration is turned on permanently.	Contact BINDER service.
Alarm message "Cascade temp. sensor"	Failure of Pt100 temperature sensor. Refrigerating machine in continuous operation (see chap. 14.4.6).	Contact BINDER service.
Alarm message "Condensate temp. sensor" or "Ambient temp. sensor"	Failure of Pt100 temperature sensor.	Contact BINDER service.
No or too low refrigerating performance.	Pt 100 sensor defective.	Contact BINDER service.
	Refrigerating system defective.	
	Semiconductor relay defective.	
	Temperature set-point not set correctly on the controller.	Set temperature set-point correctly.
	Ambient temperature too high > 32 °C (chap. 3.4).	Select cooler place of installation.
	Compressor not switched on.	Contact BINDER service.
	No or not enough refrigerant.	
	Too much external heat load.	Reduce heat load.
Alarm message "Continuous operation"	Cooling system error.	Contact BINDER service.
	Semiconductor relay defective.	
	Controller defective.	
Alarm message "Compressor defective"	Cooling system error.	Turn off the chamber and contact BINDER service.
	Condenser fan defective.	

Fault description	Possible cause	Required measures
Refrigerating performance (continued)		
Alarm message "Condenser temp."	Condenser air filter soiled.	Clean / replace the condenser air filter (chap. 25.2.1).
	Condenser soiled.	Clean the condenser (chap. 25.2.2).
	Ventilation slots are blocked.	Make sure to have free air access to the device at the front and bottom.
	Place of installation too hot.	Select cooler place of installation or contact BINDER service.
	Chamber positioned too close to the wall (spacers not mounted or twisted).	Install / check the spacers (chap. 4.2).
Humidity		
Icing at the walls of the inner chamber	Long time of continuous operation.	Defrost the chamber (chap. 25.2.3)
Controller		
No chamber function (dark display).	Power failure. Display mode "Standby" active.	With option "battery-buffered alarm system": Press any key on the controller display.
	Main power switch (4) is off.	Turn on the main power switch (4).
Menu functions not available.	Menu functions not available with current authorization level.	Log in with the required higher authorization.
No access to controller	Password incorrect.	Contact BINDER service.
Acknowledging the alarm does not cancel the alarm state.	Cause of alarm persists.	Remove cause of alarm. If the alarm state continues, contact BINDER service.

25.4 Maintenance intervals, service

 	 DANGER
	<p>Electrical hazard during live maintenance work. Deadly electric shock.</p> <ul style="list-style-type: none"> Ø The chamber must NOT become wet during operation or maintenance works. Ø Do NOT remove the rear panel of the chamber and the maintenance flaps on the chamber sides. ➤ Before conducting maintenance work, turn off the chamber at the main power switch and disconnect the power plug. ➤ General maintenance work must be conducted by licensed electricians or experts authorized by BINDER. ➤ Maintenance work at the refrigeration system must only be conducted by qualified personnel who underwent training in accordance with EN 13313:2010 (e.g. a refrigeration technician with certified expert knowledge acc. to regulation 303/2008/EC). Follow the national statutory regulations.

Ensure regular maintenance work is performed at least once a year and that the legal requirements are met regarding the qualifications of service personnel, scope of testing and documentation. All work on the refrigeration system (repairs, inspections) must be documented.



The warranty becomes void if maintenance work is conducted by non-authorized personnel.

With an increased amount of dust in the ambient air, clean the condenser fan (by suction or blowing) several times a year. Check the condenser air filter frequently and clean / replace it if necessary (chap. 25.2.1).

We recommend taking out a maintenance agreement. Please consult BINDER Service.

BINDER telephone hotline:	+49 (0) 7462 2005 555
BINDER fax hotline:	+49 (0) 7462 2005 93555
BINDER service hotline USA:	+1 866 885 9794 or +1 631 224 4340 x3 (toll-free in the USA)
BINDER service hotline Asia Pacific:	+852 390 705 04 or +852 390 705 03
BINDER Internet website	http://www.binder-world.com
BINDER address	BINDER GmbH, post office box 102, 78502 Tuttlingen, Germany

International customers, please contact your local BINDER distributor.

25.5 Service Reminder

You can display the time until the service due in the controller. Keep the **OK button** pressed down for 5 seconds.



The remaining time in days until maintenance is due is shown in the text field of the controller display.
Press the **OK button** to confirm the message.

After the recommended maintenance interval (one year of operation) a message appears on the controller.

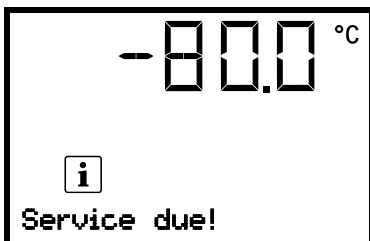

The message "Service due!" is shown in the text field of the controller display.
Press the **OK button** to confirm the message.

After one week of operation, the message reappears.

25.6 Sending the chamber back to BINDER GmbH

If you return a BINDER product to us for repair or any other reason, we will only accept the product upon presentation of an **authorization number** (RMA number) that has previously been issued to you. An authorization number will be issued after receiving your complaint either in writing or by telephone **prior** to your sending the BINDER product back to us. The authorization number will be issued following receipt of the information below:

- BINDER product type and serial number
- Date of purchase
- Name and address of the dealer from which you bought the BINDER product

26.3 Disposal of the chamber in the Federal Republic of Germany

According to Annex I of Directive 2012/19/EU of the European Parliament and of the Council on waste electrical and electronic equipment (WEEE), BINDER devices are classified as “monitoring and control instruments” (category 9) only intended for professional use”. They must not be disposed of at public collecting points.

The chambers and the optional rechargeable battery bear the symbol for the marking of electrical and electronic equipment manufactured / placed on the market in the EU after 13 August 2005 and be disposed of in separate collection according to Directive 2012/19/EU on waste electrical and electronic equipment (WEEE) and German national law for electrical and electronic equipment (Elektro- und Elektronikgerätegesetz, ElektroG). WEEE marking: crossed-out wheeled bin with solid bar under. A significant part of the materials must be recycled in order to protect the environment.

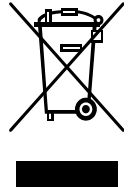



Used batteries contain substances that can be harmful to the environment and human health. These include cadmium (Cd), mercury (Hg) and lead (Pb). These substances are listed below the crossed-out wheeled bin symbol.

At the end of the device’s service life, have the chamber disposed of according to the German national law for electrical and electronic equipment (Elektro- und Elektronikgerätegesetz, ElektroG from 20 October 2015, BGBl. I p. 1739) or contact BINDER service who will organize taking back and disposal of the chamber according to the German national law for electrical and electronic equipment (Elektro- und Elektronikgerätegesetz, ElektroG from 20 October 2015, BGBl. I p. 1739).

	<div style="background-color: #00a0e3; color: white; text-align: center; padding: 5px;">NOTICE</div> <p>Violation against existing law if not disposed of properly. Failure to comply with applicable law.</p> <ul style="list-style-type: none"> ⊘ Do NOT dispose of BINDER devices at public collecting points. ➤ Have the device disposed of professionally at a recycling company which is certified according to the German national law for electrical and electronic equipment (Elektro- und Elektronikgerätegesetz, ElektroG from 20 October 2015, BGBl. I p. 1739). <li style="text-align: center;"><i>or</i> ➤ Instruct BINDER Service to dispose of the device. The general terms of payment and delivery of BINDER GmbH apply, which were valid at the time of purchasing the chamber.
--	--

Certified companies disassemble waste (used) BINDER equipment in primary substances for recycling according to Directive 2012/19/EU. The devices must be free from toxic, infectious or radioactive substances in order to eliminate any health hazards to the employees of the recycling companies.

	<p>Prior to handing the chamber over to a recycling company, it is the user’s responsibility that it is free from toxic, infectious or radioactive substances.</p> <ul style="list-style-type: none"> • Prior to disposal, clean all introduced or residual toxic substances from the chamber. • Prior to disposal, disinfect the chamber from all sources of infection. Be aware that sources of infection may also be located outside the inner chamber. • If you cannot safely remove all toxic substances and sources of infection from the chamber, dispose of it as special waste according to national law. • Fill out the contamination clearance certificate (chap. 29) and enclose it with the chamber.
---	---

	<div style="background-color: #FFA500; padding: 5px; text-align: center;">  WARNING </div> <p>Danger of intoxication and infection through contamination of the chamber with toxic, infectious or radioactive substances.</p> <p>Damages to health.</p> <ul style="list-style-type: none"> ⊘ NEVER take a chamber contaminated with toxic substances or sources of infection for recycling according to Directive 2012/19/EU. ➤ Prior to disposal, remove all toxic substances and sources of infection from the chamber. ➤ A chamber from which all toxic substances or sources of infection cannot be safely removed must be considered as “special” waste according to national law. Dispose of it accordingly.
---	---

The refrigerants used R290 (propane, GWP 3) and R170 (ethane, GWP 6) are inflammable at ambient pressure. A suction is not required. Ensure the compliance with the applicable legal requirements regarding qualification of staff, and documentation.

Chamber with option “battery-buffered alarm system”: The chamber is equipped with a rechargeable battery (12 V, 7.2 Ah) which can be recycled. As the end user, you are legally obliged to return used batteries. Old batteries and rechargeable batteries must not be disposed of with household waste. They can be handed in free of charge at the community's public collection points and wherever batteries and accumulators of the type in question are sold.

26.4 Disposal of the chamber in the member states of the EU except for the Federal Republic of Germany

According to Annex I of Directive 2012/19/EU of the European Parliament and of the Council on waste electrical and electronic equipment (WEEE), BINDER devices are classified as “monitoring and control instruments” (category 9) only intended for professional use”. They must not be disposed of at public collecting points.

The chambers and the optional rechargeable battery bear the symbol for the marking of electrical and electronic equipment manufactured / placed on the market in the EC after 13 August 2005 and be disposed of in separate collection according to the Directive 2012/19/EU on waste electrical and electronic equipment (WEEE). WEEE marking: crossed-out wheeled bin with solid bar under.

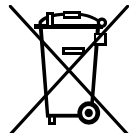

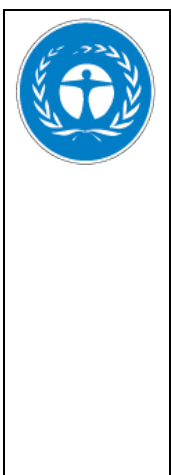

At the end of the device's service life, notify the distributor who sold you the device, who will take back and dispose of the chamber according to the Directive 2012/19/EU on waste electrical and electronic equipment (WEEE).

	<div style="background-color: #00AEEF; color: white; padding: 5px; text-align: center;"> NOTICE </div> <p>Violation against existing law if not disposed of properly.</p> <p>Failure to comply with applicable law.</p> <ul style="list-style-type: none"> ⊘ Do NOT dispose of BINDER devices at public collecting points. ➤ Have the device disposed of professionally at a recycling company that is certified according to conversion of the Directive 2012/19/EU into national law. <li style="text-align: center;"><i>or</i> ➤ Instruct the distributor who sold you the device to dispose of it. The agreements apply that were agreed with the distributor when purchasing the chamber (e.g. his general terms of payment and delivery). ➤ If your distributor is not able to take back and dispose of the chamber, please contact BINDER service.
---	---

Certified companies disassemble waste (used) BINDER equipment in primary substances for recycling according to Directive 2012/19/EU. The devices must be free from toxic, infectious or radioactive substances in order to eliminate any health hazards to the employees of the recycling companies.

	<p>Prior to handing the chamber over to a recycling company, it is the user's responsibility that it is free from toxic, infectious or radioactive substances.</p> <ul style="list-style-type: none"> • Prior to disposal, clean all introduced or residual toxic substances from the chamber. • Prior to disposal, disinfect the chamber from all sources of infection. Be aware that sources of infection may also be located outside the inner chamber. • If you cannot safely remove all toxic substances and sources of infection from the chamber, dispose of it as special waste according to national law. • Fill out the contamination clearance certificate (chap. 29) and enclose it with the chamber.
---	---

	<div style="background-color: #FFA500; padding: 5px; text-align: center;">  WARNING </div> <p>Danger of intoxication and infection through contamination of the chamber with toxic, infectious or radioactive substances.</p> <p>Damages to health.</p> <ul style="list-style-type: none"> ⊘ NEVER take a chamber contaminated with toxic substances or sources of infection for recycling according to Directive 2012/19/EU. ➤ Prior to disposal, remove all toxic substances and sources of infection from the chamber. ➤ A chamber from which all toxic substances or sources of infection cannot be safely removed must be considered as "special" waste according to national law. Dispose of it accordingly.
--	---

The refrigerants used R290 (propane, GWP 3) and R170 (ethane, GWP 6) are inflammable at ambient pressure. A suction is not required. Ensure the compliance with the applicable legal requirements regarding qualification of staff, and documentation.

Chamber with option "battery-buffered alarm system": The chamber is equipped with a rechargeable battery (12 V, 7.2 Ah) which can be recycled. The disposal of batteries within the EU must be carried out in accordance with the current EU directives as well as national, regional and local environmental protection regulations.

26.5 Disposal of the chamber in non-member states of the EU

	<div style="background-color: #00AEEF; color: white; padding: 5px; text-align: center;"> NOTICE </div> <p>Danger of violation against existing law if not disposed of properly.</p> <p>Failure to comply with applicable law. Alteration of the environment.</p> <ul style="list-style-type: none"> ➤ For final decommissioning and disposal of the chamber, please contact BINDER Service. ➤ Follow the statutory regulations for appropriate, environmentally friendly disposal.
---	---

Chamber with option "battery-buffered alarm system": The chamber is equipped with a rechargeable battery (12 V, 7.2 Ah) which can be recycled. Used batteries must be disposed of properly. Please ensure that you dispose of the battery in accordance with the regulations in force in your country.

The refrigerants used R290 (propane, GWP 3) and R170 (ethane, GWP 6) are inflammable at ambient pressure. A suction is not required. Ensure the compliance with the applicable legal requirements regarding qualification of staff, and documentation.

27. Technical description

27.1 Factory calibration and adjustment

The chambers were calibrated and adjusted in factory. Calibration and adjustment were performed using standardized test instructions, according to the QM DIN EN ISO 9001 system applied by BINDER (certified since December 1996 by TÜV CERT). All test equipment used is subject to the administration of measurement and test equipment that is also a constituent part of the BINDER QM DIN EN ISO 9001 systems. They are controlled and calibrated to a DKD-Standard at regular intervals.



Repeated calibrations are recommended in periods of 12 months.

27.2 Over current protection

The devices are equipped with an internal fuse not accessible from outside. If this fuse is blown, please inform an electronic engineer or BINDER service.

27.3 Technical data

Chamber size		350	500	700
Exterior dimensions				
Width, gross (including hinges, door lock and controller housing)	mm / inch	802 / 31.58	920 / 36.2	1204 / 47.4
Height, gross (incl. castors)	mm / inch	1966 / 77.4	1966 / 77.4	1966 / 77.4
Depth, gross (including power connection, without door lock and controller housing (equals depth when door open))	mm / inch	850 / 33.5	850 / 33.5	850 / 33.5
Depth, gross (including power connection, door lock and controller housing)	mm / inch	1005 / 39.6	1005 / 39.6	1005 / 39.6
Wall clearance rear (minimum)	mm / inch	100 / 3.9	100 / 3.9	100 / 3.9
Wall clearance side (side without hinges) (minimum)	mm / inch	100 / 3.9	100 / 3.9	100 / 3.9
Wall clearance side (side with hinges) (minimum)	mm / inch	250 / 9.84	245 / 9.6	245 / 9.6
Doors				
Number of chamber doors		1	1	1
Number of compartment doors		2	2	2
Interior dimensions				
Quantity of compartments		2	2	2
Width of inner chamber	mm / inch	486 / 19.13	606 / 23.85	890 / 35.04
Height of interior	mm / inch	1300 / 51.2	1300 / 51.2	1300 / 51.2
Height of individual compartment (with shelves)	mm / inch	312-319 12.3-12.6	312-319 12.3-12.6	312-319 12.3-12.6
Depth of inner chamber	mm / inch	604 / 23.78	604 / 23.78	604 / 23.78
Interior volume, total	l	402	491 / 17.3	728 / 25.7
Shelves				
Quantity of shelves (regular)		3	3	3
Quantity of shelves (max.)		13	13	13
Width of shelf	mm / inch	458 / 18.03	580 / 22.8	860 / 33.9
Depth of shelf	mm / inch	590 / 23.2	590 / 23.2	590 / 23.2
Permitted max. load per shelf (regular shelf)	kg / lbs	40 / 88	50 / 110	50 / 110
Permitted max. load of inner chamber bottom	kg / lbs	40 / 88	50 / 110	50 / 110
Permitted total load	kg / lbs	160 / 353	200 / 441	200 / 441

Chamber size		350	500	700
Shelves (continued)				
Quantity of stainless-steel racks per level		3	4	6
Max. quantity of cryo boxes 50 mm / 2 inch		264	352	528
Max. quantity of cryo boxes 75 mm / 3 inch		168	224	336
Temperature data				
Setting and control range	°C / °F	-40 up to -90 / -40 up to -130		
Temperature uniformity (variation) at -80 °C / -112 °F	± K	3.5	2.5	2.5
Temperature fluctuation at -80 °C / -112 °F	± K	3.5	1.5	1.5
Pull-down time from +25 °C / 71.6 °F to -80 °C / -112 °F	minutes	150	360	450
Pull-up time in case of power failure from -80 °C / -112 °F to -60 °C / -76 °F	minutes	170	230	250
Pull-up time in case of power failure from -80 °C / -112 °F to 0 °C / -32 °F	minutes	1170	2160	2220
Weight				
Weight of the chamber (empty)	kg / lbs	226 / 498	247 / 545	288 / 635
Electrical Data UF V (230 V)				
IP system of protection acc. to EN 60529	IP	20	20	20
Nominal voltage (±10%) at 50 Hz power frequency	V	230	230	230
Current type		1N~	1N~	1N~
Nominal power	kW	1.6	1.6	1.6
Nominal current	A	7.0	7.0	7.0
IEC connector plug and cable	mm / inch	2000 / 78.7	2000 / 78.7	2000 / 78.7
Power plug		Grounded plug		
Installation category acc. to IEC 61010-1		II	II	II
Pollution degree acc. to IEC 61010-1		2	2	2
Internal over-current release category C, 2 poles	A	10	10	10
Electrical Data UF V-UL (120 V)				
IP system of protection acc. to EN 60529	IP	20	20	20
Nominal voltage (+/- 10%) at 60 Hz power frequency	V	115	115	115
Current type		1N~	1N~	1N~
Nominal power	kW	1.4	1.4	1.4
Nominal current	A	11.7	11.7	11.7
IEC connector plug and cable	mm / inch	2000 / 78.7	2000 / 78.7	2000 / 78.7
Power plug	NEMA	5-15P	5-15P	5-15P
Installation category acc. to IEC 61010-1		II	II	II
Pollution degree acc. to IEC 61010-1		2	2	2
Internal over-current release category C, 2 poles	A	15	13	13

Chamber size		500	700	
Electrical Data UF V UL (208 - 230 V)				
IP system of protection acc. to EN 60529	IP	20	20	20
Nominal voltage (+/- 10%) at 60 Hz power frequency	V	208-230	208 - 230	208 - 230
Current type		2~	2~	2~
Nominal power	kW	1.6	1.6	1.6
Nominal current	A	7.7	7.7	7.7
IEC connector plug and cable	mm / inch	2000 / 78.7	2000 / 78.7	2000 / 78.7
Power plug	NEMA	6-15P	6-15P	6-15P
Installation category acc. to IEC 61010-1		II	II	II
Pollution degree acc. to IEC 61010-1		2	2	2
Internal over-current release category C, 2 poles	A	10	10	10
Environment-specific data UF V (230 V)				
Noise level (mean value)	dB (A)	59	47	47
Energy consumption at -80 °C/ -112 °F, with an ambient temperature of +25 °C / 77°F; +/- 10%	kWh/day	7.9	7,9	8,1
Heat dissipation at set-point -80 °C / -112 °F	Wh/h	330	330	340
Filling weight of refrigerant R290 (propane) (1 st stage cooling, GWP 3)	kg	0.15	0.15	0.15
Filling weight of refrigerant R170 (ethane) (2 nd stage cooling, GWP 6)	kg	0.135	0.15	0.15
UF V with water cooling: Filling weight of refrigerant R290 (propane) (1 st stage cooling, GWP 3)	kg	---	0.15	0.15
UF V with water cooling: Filling weight of refrigerant R170 (ethane) (2 nd stage cooling, GWP 6)	kg	---	0.15	0.15
Environment-specific data UF V-UL (120 V)				
Noise level (mean value)	dB (A)	59	47	47
Energy consumption at -80 °C/ -112 °F, with an ambient temperature of +25 °C / 77°F; +/- 10%	kWh/day	7.9	7.9	8.1
Filling weight of refrigerant R290 (propane) (1 st stage cooling, GWP 3)	kg	0.15	0.15	0.15
Filling weight of refrigerant R170 (ethane) (2 nd stage cooling, GWP 6)	kg	0.135	0.15	0.15
Environment-specific data UF V UL (208-230 V)				
Noise level (mean value)	dB (A)	59	47	47
Energy consumption at -80 °C/ -112 °F, with an ambient temperature of +25 °C / 77°F; +/- 10%	kWh/day	7.9	7.9	8.1
Filling weight of refrigerant R290 (propane) (1 st stage cooling, GWP 3)	kg	0.15	0.15	0.15
Filling weight of refrigerant R170 (ethane) (2 nd stage cooling, GWP 6)	kg	0.135	0.15	0.15

All technical data is specified for chambers with unloaded standard equipment at an ambient temperature of +22 °C +/- 3°C / 71.6 °F +/- 5.4 °F and a power supply voltage fluctuation of +/-10. Technical data is determined in accordance to BINDER Factory Standard Part 2:2015 and DIN 12880:2007.

All indications are average values, typical for chambers produced in series. We reserve the right to change technical specifications at any time.

27.4 Equipment and options (extract)



To operate the chamber, use only original BINDER accessories or accessories / components from third-party suppliers authorized by BINDER. The user is responsible for any risk arising from using unauthorized accessories.

Regular equipment
RD4 microprocessor controller for temperature
Electronic error auto-diagnosis system with zero-voltage relay alarm output
Ethernet interface for computer communication
USB interface
Safety controller
VIP technology (vacuum insulation panels)
Powerful, energy-efficient refrigeration system
4 compartments, 2 compartment doors
3 shelves
Two 28 mm access ports
Connection kit for cooling water (UF V with water cooling, only UF V 500 and UF V 700)
Voltage 230 V
Voltage 115 V or 208 V-240 V

Options / accessories
Stainless steel shelf set, 1 shelf with shelf holders
Door access system, consisting of electromechanical door locking und Electronic access control via NumPad (option for UF V 500 et UF V 700)
Battery-buffered alarm system
Lockable protective flap for the main power switch
Deicing kit, consisting of drain well for condensate, wiper, adhesive tape scratch, ice scraper
CO ₂ emergency cooling
Advanced voltage booster (buck/boost controller)
Analog output 4-20 mAmp for temperature with 6 pole DIN socket, DIN plug included
BINDER Pure Aqua Service
Exchange cartridge for BINDER Pure Aqua Service
Chamber inventory: side access racks, sliding drawer racks, cryo boxes
Calibration of temperature including certificate
Spatial temperature measurement including certificate
Qualification folder

27.5 Optional equipment, accessories and spare parts (extract)



BINDER GmbH is responsible for the safety features of the chamber only provided skilled electricians or qualified personnel authorized by BINDER perform all maintenance and repair, and if components relating to chamber safety are replaced in the event of failure with original spare parts. The user is responsible for any risks arising from using unauthorized accessories / components.

Chamber Size	350	500	700
Description	Art. no.		
Outer chamber door gasket, silicon	6005-0344	6005-0278	6005-0279
Inner chamber door gasket, silicon	6005-0345	6005-0273	6005-0274
Compartment door, regular	8003-0376	8003-0034	8003-0036
Compartment door with gasket, foamed (option)	8003-0375	8003-0298	8003-0299
Standard shelf for compartment	4005-0705	4005-0604	4005-0605
Stainless steel shelf set, 1 shelf with shelf holders	8012-2276	8012-1901	8012-1902
Deicing kit (complete set), consisting of	8012-2275	8012-0748	8012-0747
drain well for condensate, with gasket	8009-1210	8009-0650	8009-0503
Wiper (rubber to wipe off water)	1007-0142	1007-0142	1007-0142
Adhesive tape scratch	6007-0037	6007-0037	6007-0037
Ice scraper	6002-0433	6002-0433	6002-0433

Description	Art. no.
Rechargeable battery 12V, 7.2 Ah	5007-0001
Replacement condenser air filter	6014-0037
Fuse 4A / 250V - F - 6,3x32mm	5006-0074
Over-current release category C 10 A (for UF V and UF V UL 208-240V)	5006-0084
IEC connector plug for EU with 2 m cable, with internal locking system	5023-0245
IEC connector plug for Switzerland with 2 m cable	5023-0246
IEC connector plug for UK with 2 m cable	5023-0247
IEC connector plug for EU with 5 m cable	5023-0283
IEC connector plug for Switzerland with 5 m cable	5023-0284
IEC connector plug for UK with 5 m cable	5023-0285
Insulated compartment doors UFV 350 E3	8012-2274
Insulated compartment doors UFV 500 E3	8012-1893
Insulated compartment doors UFV 700 E3	8012-1894
Front castor with lock	6006-0029
Rear castor	6006-0028
Wiper (rubber to wipe off water)	1007-0142
Ice scraper	6002-0433
Glove, deep temperature, medium size	1007-0141
Neutral cleaning agent, 1 kg	1002-0016
Document pocket with magnetic strip, DIN A4	1007-0098
Lockable protective flap for the main power switch	8007-0544
Lockable door handle	8012-1911
Connection kit for cooling water (UF V with water cooling)	8009-0820

Description	Art. no.
CO ₂ emergency cooling UF V (E3) mounted, adjustable between -40 °C / -40 °F and -70 °C / -94 °F.	8012-1891
CO ₂ emergency cooling UF V (E3) retrofit kit, installation by BINDER Service. Adjustable between -40 °C / -40 °F and -70 °C / -94 °F, retrofit possible	8012-1892
Advanced voltage booster (option only for UF V) (option)	8012-0762
Side access rack, stainless steel, empty No. of sections (D x H) 20 (4x5) for boxes (height) 50 mm / 2 inch	6017-0043
Side access rack, stainless steel, empty No. of sections (D x H) 24 (4x6) for boxes (height) 50 mm / 2 inch	6017-0049
Side access rack, aluminum, empty No. of sections (D x H) 20 (4x5) for boxes (height) 50 mm / 2 inch	6017-0041
Side access rack, aluminum, empty No. of sections (D x H) 24 (4x6) for boxes (height) 50 mm / 2 inch	6017-0047
Sliding drawer rack stainless steel, empty No. of sections (D x H) 20 (4x5) for boxes (height) 50 mm / 2 inch	6017-0045
Sliding drawer rack stainless steel, empty No. of sections (D x H) 24 (4x6) for boxes (height) 50 mm / 2 inch	6017-0051
Side access rack, stainless steel, with cryo boxes No. of sections (D x H) 20 (4x5) for boxes (height) 50 mm / 2 inch	6017-0044
Side access rack, stainless steel, with cryo boxes No. of sections (D x H) 24 (4x6) for boxes (height) 50 mm / 2 inch	6017-0050
Side access rack, aluminum, with cryo boxes No. of sections (D x H) 20 (4x5) for boxes (height) 75 mm / 3 inch	6017-0042
Side access rack, aluminum, with cryo boxes No. of sections (D x H) 24 (4x6) for boxes (height) 50 mm / 2 inch	6017-0048
Sliding drawer rack, stainless steel, with cryo boxes No. of sections (D x H) 20 (4x5) for boxes (height) 50 mm / 2 inch	6017-0046
Sliding drawer rack, stainless steel, with cryo boxes No. of sections (D x H) 24 (4x6) for boxes (height) 50 mm / 2 inch	6017-0052
Set of 36 cryo boxes, cardboard, with dividers 9x9, white height 50 mm / 2 inch	6017-0053

Validation service	Art. no.
Qualification folder IQ-OQ (printed version)	7007-0001
Qualification folder IQ-OQ (digital version)	7057-0001
Qualification folder IQ-OQ-PQ (printed version)	7007-0005
Qualification folder IQ-OQ-PQ (digital version)	7057-0005
Execution of IQ-OQ	DL410200
Execution of IQ-OQ-PQ	DL440500

Calibration service	Art. no.
Calibration of temperature including certificate (1 measuring point)	DL300201
Spatial temperature measurement including certificate (20 measuring points)	DL300620

For information on components not listed here, please contact BINDER Service.

27.6 Dimensions of UF V 350 (E3)

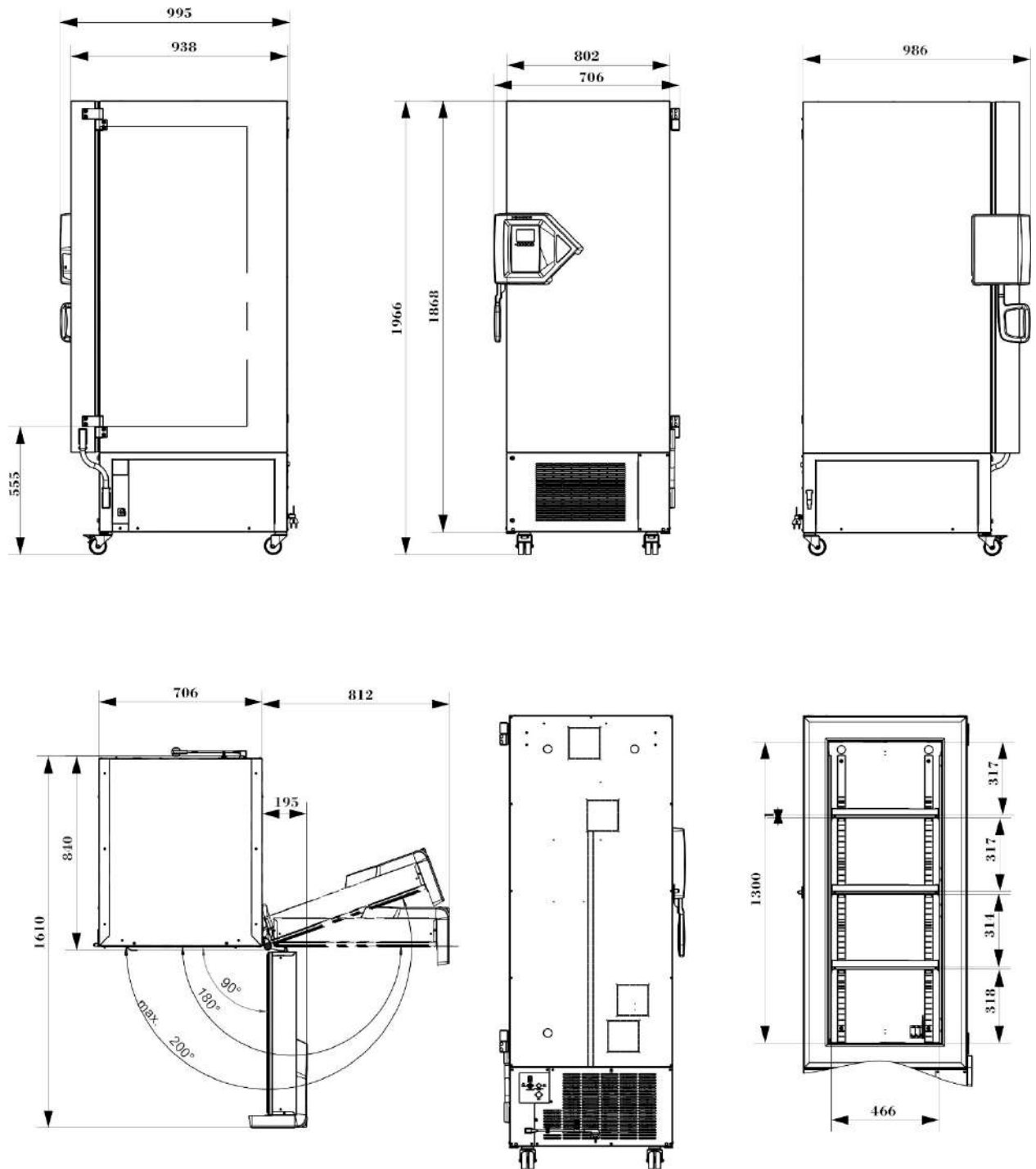

Dimensions in mm

27.7 Dimensions of UF V 500 (E3)

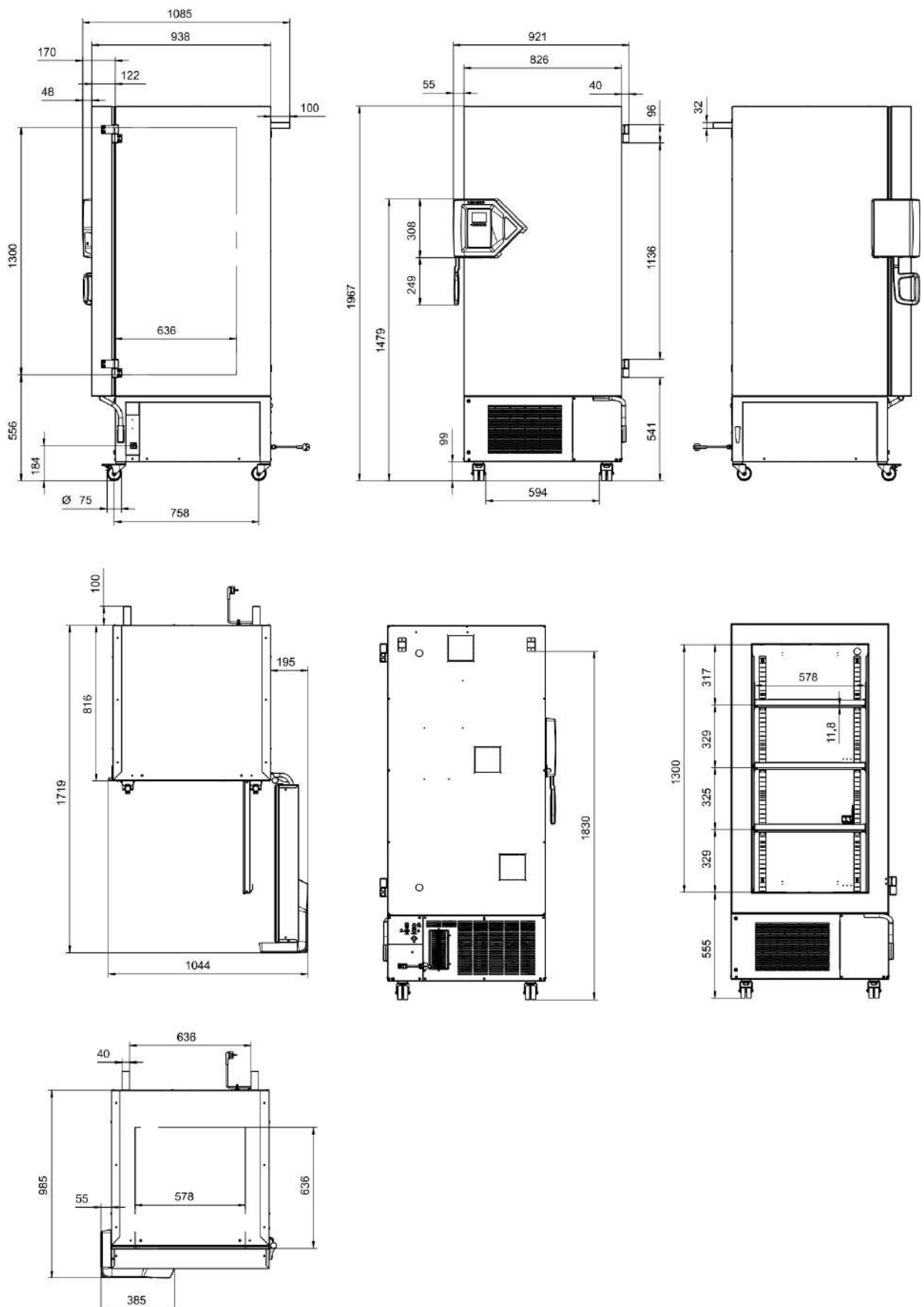

Dimensions in mm

27.8 Dimensions of UF V 700 (E3)

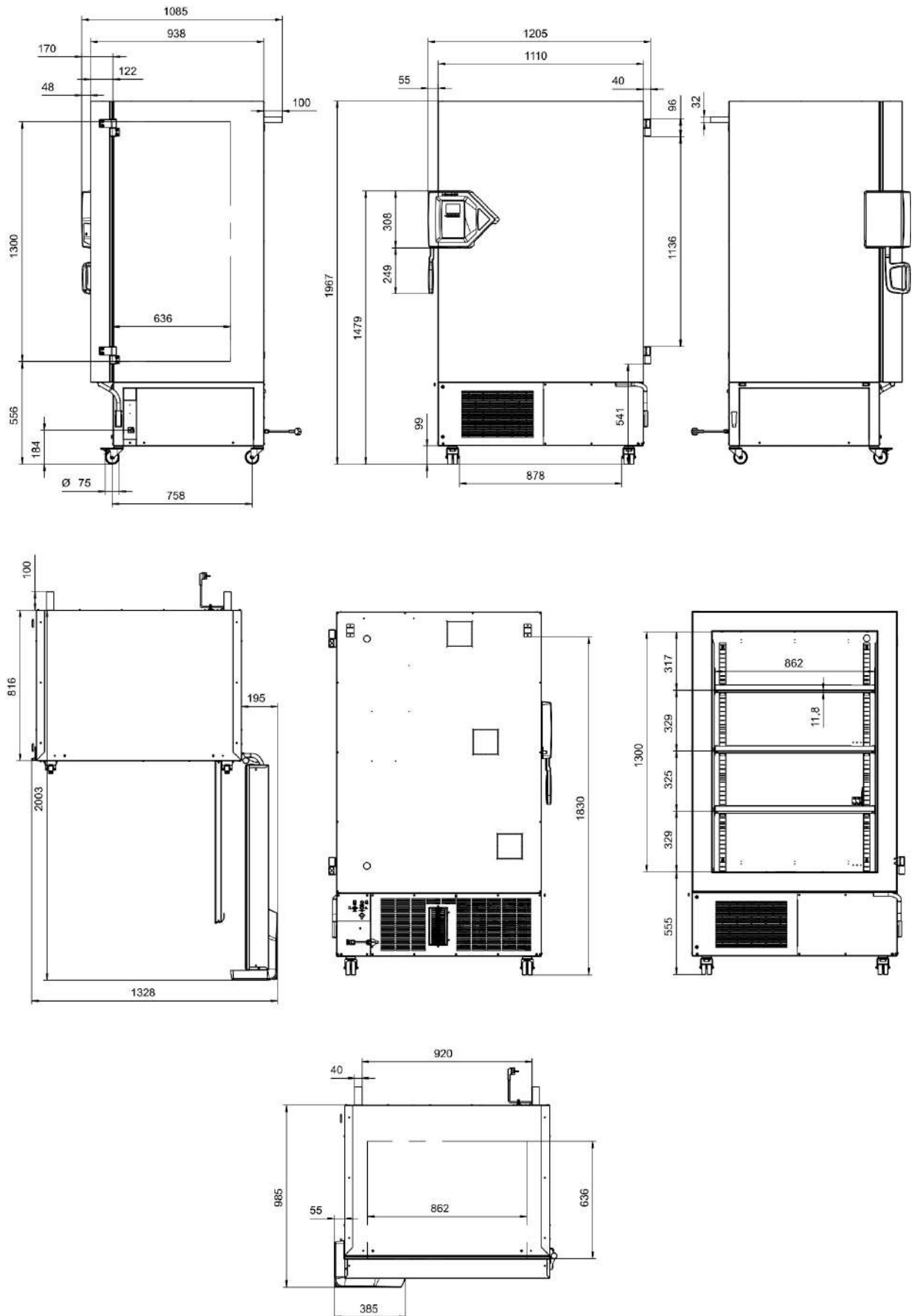

Dimensions in mm

28. Certificates and declarations of conformity

28.1 EU Declaration of Conformity

	EU-Konformitätserklärung / EU Declaration of Conformity / Déclaration de conformité UE / Declaración de conformidad UE / Dichiarazione di conformità UE / Декларация соответствия EU
Hersteller / Manufacturer / Fabricant / Fabricante / Fabbicante / Производитель	BINDER GmbH
Anschrift / Address / Adresse / Dirección / Indirizzo / Адрес	Im Mittleren Ösch 5, 78532 Tuttlingen, Germany
Produkt / Product / Produit / Producto / Prodotto / Продукт	Ultra-Tiefkühlschränke / Freezer Ultra low temperature freezers Congélateurs à ultra-basse température Congeladores de ultrabaja temperatura Congelatori a bassissima temperatura Низкотемпературные Морозильники
Typenbezeichnung / Type / Type / Tipo / Tipo / Тип	UF V 350, UF V 500, UF V 700
Art. No. / Art. no. / Réf. / Art. N° / Art. n. / № арт.	9020-0453, 9120-0453, 9020-0454, 9120-0454, 9020-0455, 9120-0455, 9020-0347, 9120-0347, 9020-0348, 9120-0348, 9020-0351, 9120-0351, 9020-0353, 9120-0353, 9020-0352, 9120-0352, 9020-0354, 9120-0354, 9020-0349, 9120-0349, 9020-0350, 9120-0350

Die oben beschriebenen Produkte sind konform mit folgenden EU-Richtlinien:
 The products described above are in conformity with the following EU Directives:
 Les produits décrits ci-dessus sont conformes aux directives UE suivantes:
 Los productos descritos arriba cumplen con las siguientes directivas de la UE:
 I prodotti sopra descritti sono conformi alle seguenti direttive UE:
 Продукты, указанные выше, полностью соответствуют следующим EU руководствам:

- **2014/35/EU**
Niederspannungsrichtlinie 2014/35/EU / Low voltage directive 2014/35/EU / Directive basse tension 2014/35/UE / Directiva sobre baja tensión 2014/35/UE / Direttiva Bassa tensione 2014/35/UE / Директива по низкому напряжению 2014/35/EU
- **2014/30/EU**
EMV-Richtlinie 2014/30/EU / EMC Directive 2014/30/EU / Directive CEM 2014/30/UE / Directiva CEM 2014/30/UE / Direttiva EMC 2014/30/UE / Директива ЭМС 2014/30/EU
- **2011/65/EU, (EU) 2015/863**
RoHS-Richtlinien 2011/65/EU und (EU) 2015/863 / RoHS Directives 2011/65/EU and (EU) 2015/863 / Directives RoHS 2011/65/UE et (UE) 2015/863 / Directivas RoHS 2011/65/UE y (UE) 2015/863 / Direttive RoHS 2011/65/UE et (UE) 2015/863 / Директивы RoHS 2011/65/EU и (EU) 2015/863

1 / 2

Die oben beschriebenen Produkte tragen entsprechend die Kennzeichnung CE.
The products described above, corresponding to this, bear the CE-mark.
Les produits décrits ci-dessus, en correspondance, portent l'indication CE.
Los productos descritos arriba, en conformidad, llevan la indicación CE.
I prodotti sopra descritti, conformi a quanto sopra, portano il marchio CE.
Данные продукты в соответствии с изложенным выше маркированы знаком CE.

Die oben beschriebenen Produkte sind konform mit folgenden harmonisierten Normen:
The products described above are in conformity with the following harmonized standards:
Les produits décrits ci-dessus sont conformes aux normes harmonisées suivantes:
Los productos descritos arriba cumplen con las siguientes normas:
I prodotti sopra descritti sono conformi alle seguenti normative armonizzate:
Продукты, указанные выше, полностью соответствуют следующим стандартам:

Sicherheit / Safety / Sécurité / Seguridad / Sicurezza / Нормативы по безопасности
<ul style="list-style-type: none">• EN 61010-1:2010+A1:2019+A1:2019/AC:2019• EN 60204-1:2018
EMV / EMC / CEM / CEM / EMC / ЭМС
<ul style="list-style-type: none">• EN 61326-1:2013
RoHS
<ul style="list-style-type: none">• EN IEC 63000:2018

78532 Tuttlingen, 24.04.2023
BINDER GmbH



P. Wimmer
Vice President
Vice President
Vice président
Vicepresidente
vicepresidente
Вице-президент



J. Bollaender
Leiter F & E
Director R & D
Chef de service R&D
Responsable I & D
Direttore R & D
Глава департамента R&D

2 / 2

28.2 UKCA Declaration of Conformity



UK CA	UKCA Declaration of Conformity
------------------	---------------------------------------

Name and address of manufacturer	BINDER GmbH Im Mittleren Ösch 5, 78532 Tuttlingen, Germany
Name and address of UK Authorised Representative	Comply Express Ltd Unit C2, Coalport House, Stafford Park 1, Telford TF3 3BD
Object of the Declaration	Ultra low temperature freezers
Type Designation	UF V 350, UF V 500, UF V 700
BINDER Art. No.	9020-0347, 9120-0347, 9020-0348, 9120-0348 9020-0349, 9120-0349, 9020-0350, 9120-0350

The Objects of the Declaration described above are in conformity with the relevant UK Regulations and UK Guidelines:

- **Electrical Equipment (Safety) Regulations 2016**
Statutory Instruments 2016 No. 1101 – Consumer Protection Health and safety
- **Electromagnetic Compatibility Regulations 2016**
Statutory Instruments 2016 No. 1091 – Electromagnetic Compatibility
- **The Restriction of the Use of Certain Hazardous Substances in Electrical and Electronic Equipment Regulations 2012**
Statutory Instruments 2012 No. 3032 – Environmental Protection

References of standards and/or technical specifications applied for this Declaration of Conformity, or parts thereof:

S.I. 2016 No. 1101:	EN 61010-1:2010 EN 60204-1:2018
S.I. 2016 No. 1091:	EN 61326-1:2013
S.I. 2012 No. 3032:	EN IEC 63000:2018

This Declaration is issued under the sole responsibility of the manufacturer.

	Tuttlingen	24.04.2023			
Place	Date		P. Wimmer Vice President	J. Bollaender Director R & D	BINDER GmbH

BINDER GmbH
Im Mittleren Ösch 5
78502 Tuttlingen
Deutschland

Tel: +49 (0) 74 62 / 20 05 - 0
Fax: +49 (0) 74 62 / 20 05 - 100
info@binder-world.com
www.binder-world.com

Geschäftsführung:
Dipl.-Ing. Peter M. Binder
Amtsgericht Stuttgart, HRB 727150
Sitz der Gesellschaft: Tuttlingen
Ust.-ID.-Nr.: DE815021304

Kreissparkasse Tuttlingen
IBAN: DE05 6435 0070 0000 0022 66
SWIFT: SOLA DE 51TUT
Deutsche Bank Tuttlingen
IBAN: DE56 6537 0075 0213 8709 00
SWIFT: DEUT DE 55653

28.3 Certificate for the GS mark of conformity of the “VDE Prüf- und Zertifizierungsinstitut” (Testing and Certification Institute of the Association for Electrical, Electronic and Information Technologies)

Note: UF V 350 and chambers equipped with the optional CO₂ emergency cooling do not bear the GS mark.

VDE Prüf- und Zertifizierungsinstitut

**ZEICHENGENEHMIGUNG
MARKS APPROVAL**

Binder GmbH
Im Mittleren Osch 5
78532 Tuttlingen
Germany

ist berechtigt für ihr Produkt /
is authorized to use for their product
**Klimaschrank
Air conditioning cabinet**

die hier abgebildeten markenrechtlich geschützten Zeichen
für die ab Blatt 2 aufgeführten Typen zu benutzen /
the legally protected Marks as shown below for the types referred to on page 2 ff.

Geprüft und zertifiziert nach /
Tested and certified according to

DIN EN 61010-1 (VDE 0411 Teil 1) 2011-07, EN 61010-1:2010-10
DIN EN 61010-2-011 (VDE 0411-2-011) 2017-12, EN 61010-2-011:2017
Das Produkt erfüllt sich die Anforderungen nach /
The product also fulfills the requirements of
IEC 61010-1:2010
IEC 61010-2-011:2016

Das Produkt entspricht den Anforderungen des deutschen Produktsicherheitsgesetzes (ProdSG)
hinsichtlich der Gewährleistung von Sicherheit und Gesundheit.
The product covers the requirements of the German Act "Produktsicherheitsgesetz" (ProdSG)
regarding the assurance of safety and health.

Befristet zum / valid until: 2025-08-30

Altanzahl: 1792300-2946-0001 / 248793
File ref.
Ausweis-Nr. /
Certificate No. 40052617
Blatt /
Page 1

VDE Prüf- und Zertifizierungsinstitut GmbH
VDE Testing and Certification Institute
Zertifizierungsstelle /
Certification

Offenbach, 2020-10-30

VDE Prüf- und Zertifizierungsinstitut GmbH
VDE Testing and Certification Institute
Fahrgeliet TL4
Seckon TL4

**VDE Prüf- und Zertifizierungsinstitut
Zeichengenehmigung**

Address-Nr. /
Certificate No. 40052617

Blatt /
Page 2

Name und Sitz des Genehmigungs-Inhabers / Name and registered seat of the Certificate holder:
Binder GmbH, Im Mittleren Osch 5, 78532 Tuttlingen

Altanzahl / File ref.
1792300-2946-0001 / 248793 / TL4 / ZIE

Datum / Date
2020-10-30

Dieses Blatt gilt nur in Verbindung mit Blatt 1 des Zeichengenehmigungsausweises Nr. 40052617.
This supplement is only valid in conjunction with page 1 of the Certificate No. 40052617.

**Klimaschrank
Air conditioning cabinet**

Typent / Typen
UF V 600
UF V 700

Weitere Angaben
Further information
siehe Anlage Nr. 1 / 2020-10-30
see attachment 1 / 2020-10-30

PAK AFS GS 2010 01PAK
FAH AFS GS 2010 01PAH

Das Produkt entspricht den Anforderungen gemäß
Satz-Genehmigung AFS GS
2010 01PAK.
The product is in accordance with the requirements of
Mark-Genehmigung AFS
GS 2010 01PAK.

VDE Prüf- und Zertifizierungsinstitut GmbH
VDE Testing and Certification Institute
Fahrgeliet TL4
Seckon TL4

**VDE Prüf- und Zertifizierungsinstitut
Zeichengenehmigung**

Address-Nr. /
Certificate No. 40052617

Blatt /
Supplement

Name und Sitz des Genehmigungs-Inhabers / Name and registered seat of the Certificate holder:
Binder GmbH, Im Mittleren Osch 5, 78532 Tuttlingen

Altanzahl / File ref.
1792300-2946-0001 / 248793 / TL4 / ZIE

Datum / Date
2020-10-30

Dieses Blatt ist Bestandteil des Zeichengenehmigungsausweises Nr. 40052617.
This supplement is part of the Certificate No. 40052617.

**Klimaschrank
Air conditioning cabinet**

Fertigungsstätte(n)
Place(s) of manufacture

Referenz/Reference
30007940

Binder GmbH
Ginsacker 16
78532 Tuttlingen

VDE Prüf- und Zertifizierungsinstitut GmbH
VDE Testing and Certification Institute
Fahrgeliet TL4
Seckon TL4

**VDE Prüf- und Zertifizierungsinstitut
Zeichengenehmigung**

Address-Nr. /
Certificate No. 40052617

Blatt /
Supplement

Name und Sitz des Genehmigungs-Inhabers / Name and registered seat of the Certificate holder:
Binder GmbH, Im Mittleren Osch 5, 78532 Tuttlingen

Altanzahl / File ref.
1792300-2946-0001 / 248793 / TL4 / ZIE

Datum / Date
2020-10-30

Dieses Blatt gilt nur in Verbindung mit Blatt 1 des Zeichengenehmigungsausweises Nr. 40052617.
This supplement is only valid in conjunction with page 1 of the Certificate No. 40052617.

**Genehmigung zum Benutzen des auf Seite 1 abgebildeten markenrechtlich geschützten Zeichens des
VDE:**

Grundlage für die Benutzung sind die Allgemeinen Geschäftsbedingungen (AGB) der VDE Prüf- und
Zertifizierungsinstitut GmbH (www.vde.com/AGB-Institut). Das Recht zur Benutzung erstreckt sich nur auf die
benannte Firma mit den genannten Fertigungsstätten und die oben aufgeführten Produkte mit den
zugehörigen Bezeichnungen. Die Fertigungsstätte muss so eingetragen sein, dass eine gleichmäßige
Herstellung der geordneten und zertifizierten Ausführung gewährleistet ist.
Die Genehmigung ist so lange gültig wie die VDE-Bestimmungen gelten, die der Zertifizierung zugrunde liegen
haben, sofern sie nicht auf Grund anderer Bedingungen aus der VDE Prüf- und Zertifizierungsinstitut (PM102)
zurückgezogen werden muss.
Der Gültigkeitsbereich einer VDE-GS-Zeichengenehmigung kann auf Antrag verlängert werden. Bei
gesetzlichen und / oder normativen Änderungen kann die VDE-GS-Zeichengenehmigung ihre Gültigkeit zu
einem früheren als dem angegebenen Datum verlieren.
Produkte, die das Europäische Übereinkommen (EMV) erfüllen, dürfen gemäß der Kommissionsentscheidung
2002/591/EG nicht mehr in den Verkehr gebracht oder auf dem Markt bereitgestellt werden.
Der VDE-Zeichengenehmigungsausweis wird ausschließlich auf der ersten Seite unterzeichnet.

Approval to use the legally protected Mark of the VDE as shown on the first page:
Basis für die Nutzung sind die Allgemeinen Geschäftsbedingungen und die Bedingungen der VDE Prüf- und
Zertifizierungsinstitut GmbH (www.vde.com/terms-conditions). Das Recht zur Nutzung ist ausschließlich der
benannten Firma mit den genannten Fertigungsstätten und den oben aufgeführten Produkten mit den
zugehörigen Bezeichnungen zuerkannt. Die Fertigungsstätte muss so eingetragen sein, dass eine gleichmäßige
Herstellung der geordneten und zertifizierten Ausführung gewährleistet ist.
Die Genehmigung ist so lange gültig wie die VDE-Bestimmungen gelten, die der Zertifizierung zugrunde liegen
haben, sofern sie nicht auf Grund anderer Bedingungen aus der VDE Prüf- und Zertifizierungsinstitut (PM102)
zurückgezogen werden muss.
Der Gültigkeitsbereich einer VDE-GS-Zeichengenehmigung kann auf Antrag verlängert werden. Bei
gesetzlichen und / oder normativen Änderungen kann die VDE-GS-Zeichengenehmigung ihre Gültigkeit zu
einem früheren als dem angegebenen Datum verlieren.
Produkte, die das Europäische Übereinkommen (EMV) erfüllen, dürfen gemäß der Kommissionsentscheidung
2002/591/EG nicht mehr in den Verkehr gebracht oder auf dem Markt bereitgestellt werden.
Der VDE-Zeichengenehmigungsausweis wird ausschließlich auf der ersten Seite unterzeichnet.

28.4 Certificate of UL Compliance from Underwriters Laboratories Inc.®

Note: UF V 350-UL and chambers equipped with the optional CO₂ emergency cooling do not bear the cUL test mark.

Certified for Canada

CERTIFICATE OF COMPLIANCE

Certificate Number: UL-CA-2009650-0
Report Reference: E200795-20201218
Date: 15-Jan-2021

Issued to: BINDER GMBH
 IM MITTLEREN OESCH 5 TUTTLINGEN
 Germany 78532

This is to certify that representative samples of

OGTK7 - Laboratory-use Electrical Equipment Certified for Canada
 See Addendum Page for Product Designation(s).

Have been investigated by UL in accordance with the Standard(s) indicated on this Certificate.

Standard(s) for Safety: CSA C22.2 NO. 61010-1, 3rd Ed., Issue Date: 2012-05-11, Revision Date: 2016-04-29

Additional Information: See the UL Online Certification's Directory at <https://fo.ul.com/sector.com> for additional information

This Certificate of Compliance does not provide authorization to apply the UL Mark. Only the UL Follow-Up Services Procedure provides authorization to apply the UL Mark.

Only those products bearing the UL Mark should be considered as being UL Certified and covered under UL's Follow-Up Services.

Look for the UL Certification Mark on the product.



CERTIFICATE OF COMPLIANCE

Certificate Number: UL-CA-2009650-0
Report Reference: E200795-20201218
Date: 15-Jan-2021

This is to certify that representative samples of the product as specified on this certificate were tested according to the current UL requirements.

Model	Category Description
UF-V 350-UL	Laboratory Equipment
UF-V 700-UL	Laboratory Equipment



Certified for the USA

CERTIFICATE OF COMPLIANCE

Certificate Number: UL-US-2012318-0
Report Reference: E200795-20201218
Date: 15-Jan-2021

Issued to: BINDER GMBH
 IM MITTLEREN OESCH 5 TUTTLINGEN
 Germany 78532

This is to certify that representative samples of

OGTK7 - Laboratory-use Electrical Equipment
 See Addendum Page for Product Designation(s).

Have been investigated by UL in accordance with the Standard(s) indicated on this Certificate.

Standard(s) for Safety: UL 61010-1, 3rd Ed., Issue Date: 2012-05-11, Revision Date: 2016-04-29, UL 61010-2-011, 1st Ed., Issue Date: 2017-01-31

Additional Information: See the UL Online Certification's Directory at <https://fo.ul.com/sector.com> for additional information

This Certificate of Compliance does not provide authorization to apply the UL Mark. Only the UL Follow-Up Services Procedure provides authorization to apply the UL Mark.

Only those products bearing the UL Mark should be considered as being UL Certified and covered under UL's Follow-Up Services.

Look for the UL Certification Mark on the product.



CERTIFICATE OF COMPLIANCE

Certificate Number: UL-US-2012318-0
Report Reference: E200795-20201218
Date: 15-Jan-2021

This is to certify that representative samples of the product as specified on this certificate were tested according to the current UL requirements.

Model	Category Description
UF-V 350-UL	Laboratory Equipment
UF-V 700-UL	Laboratory Equipment



29. Contamination clearance certificate

29.1 For chambers located outside the USA and Canada

Declaration regarding safety and health

Erklärung zur Sicherheit and gesundheitlichen Unbedenklichkeit

The German Ordinance on Hazardous Substances (GefStofV), and the regulations regarding safety at the workplace, require that this form be filled out for all products that are returned to us, so that the safety and the health of our employees can be guaranteed.

Die Sicherheit und Gesundheit unserer Mitarbeiter, die Gefahrstoffverordnung GefStofV und die Vorschriften zur Sicherheit am Arbeitsplatz machen es erforderlich, dass dieses Formblatt für alle Produkte, die an uns zurückgeschickt werden, ausgefüllt wird.



Note: A repair is not possible without a completely filled out form.
Ohne Vorliegen des vollständig ausgefüllten Formblattes ist eine Reparatur nicht möglich.

- A completely filled out form must be transmitted via Fax (+49 (0) 7462 2005 93555) or by letter in advance, so that this information is available before the equipment/component part arrives. A second copy of this form must accompany the equipment/component part. In addition, the carrier should be notified.

Eine vollständig ausgefüllte Kopie dieses Formblattes soll per Fax unter Nr. +49 (0) 7462 2005 93555 oder Brief vorab an uns gesandt werden, so dass die Information vorliegt, bevor das Gerät/Bauteil eintrifft. Eine weitere Kopie soll dem Gerät/Bauteil beigefügt sein. Ggf. ist die Spedition zu informieren.

- Incomplete information or non-conformity with this procedure will inevitably lead to substantial delays in processing. Please understand the reason for this measure, which lies outside our area of influence, and help us to speed up this procedure.

Unvollständige Angaben oder Nichteinhalten dieses Ablaufs führen zwangsläufig zu beträchtlichen Verzögerungen in der Abwicklung. Bitte haben Sie Verständnis für Maßnahmen, die außerhalb unserer Einflussmöglichkeiten liegen und helfen Sie mit, den Ablauf zu beschleunigen.

- **Please fill out this form completely**

Bitte unbedingt vollständig ausfüllen!

1.	Unit/ component part / type / Gerät / Bauteil / Typ:
2.	Serial No. / Serien-Nr.:
3.	Details about utilized substances / biological substances / Einzelheiten über die eingesetzten Substanzen/biologische Materialien:
3.1	Designations / Bezeichnungen:
a)	_____
b)	_____
c)	_____
3.2	Safety measures required for handling these substances / Vorsichtsmaßnahmen beim Umgang mit diesen Stoffen:
a)	_____
b)	_____
c)	_____

3.3	Measures to be taken in case of skin contact or release into the atmosphere / Maßnahmen bei Personenkontakt oder Freisetzung: a) _____ b) _____ c) _____ d) _____
3.4	Other important information that must be taken into account / Weitere zu beachtende und wichtige Informationen: a) _____ b) _____ c) _____
4.	Declaration on the risk of these substances (please checkmark the applicable items) / Erklärung zur Gefährlichkeit der Stoffe (bitte Zutreffendes ankreuzen) :
	<input type="checkbox"/> 4.1 For non toxic, non radioactive, biologically harmless materials / für nicht giftige, nicht radioaktive, biologisch ungefährliche Stoffe: We hereby guarantee that the above-mentioned unit / component part... / Wir versichern, dass o.g. Gerät/Bauteil... <input type="checkbox"/> Has not been exposed to or contains any toxic or otherwise hazardous substances / weder giftige noch sonstige gefährliche Stoffe enthält oder solche anhaften. <input type="checkbox"/> That eventually generated reaction products are non-toxic and also do not represent a hazard / auch evtl. entstandene Reaktionsprodukte weder giftig sind noch sonst eine Gefährdung darstellen. <input type="checkbox"/> Eventual residues of hazardous substances have been removed / evtl. Rückstände von Gefahrstoffen entfernt wurden.
	<input type="checkbox"/> 4.2 For toxic, radioactive, biologically harmful or hazardous substances, or any other hazardous materials / für giftige, radioaktive, biologisch bedenkliche bzw. gefährliche Stoffe oder anderweitig gefährliche Stoffe. We hereby guarantee that ... / Wir versichern, dass ... <input type="checkbox"/> The hazardous substances, which have come into contact with the above-mentioned equipment / component part, have been completely listed under item 3.1 and that all information in this regard is complete / die gefährlichen Stoffe, die mit dem o.g. Gerät/Bauteil in Kontakt kamen, in 3.1 aufgelistet sind und alle Angaben vollständig sind. <input type="checkbox"/> That the unit /component part has not been in contact with radioactivity / das Gerät/Bauteil nicht mit Radioaktivität in Berührung kam
5.	Kind of transport / transporter / Transportweg/Spediteur: Transport by (means and name of transport company, etc.) / Versendung durch (Name Spediteur o.ä.) _____ Date of dispatch to BINDER GmbH / Tag der Absendung an BINDER GmbH: _____

We hereby declare that the following measures have been taken / Wir erklären, dass folgende Maßnahmen getroffen wurden:

- Hazardous substances were removed from the unit including component parts, so that no hazard exists for any person in the handling or repair of these items / das Gerät/Bauteil wurde von Gefahrstoffen befreit, so dass bei Handhabung/Reparaturen für die betreffenden Person keinerlei Gefährdung besteht
- The unit was securely packaged and properly identified / das Gerät wurde sicher verpackt und vollständig gekennzeichnet.
- Information about the hazardousness of the shipment (if required) has been provided to the transporter / der Spediteur wurde (falls vorgeschrieben) über die Gefährlichkeit der Sendung informiert.

We hereby commit ourselves and guarantee that we will indemnify BINDER GmbH for all damages that are a consequence of incomplete or incorrect information provided by us, and that we will exempt BINDER GmbH from eventual damage claims by third parties. / Wir versichern, dass wir gegenüber BINDER für jeden Schaden, der durch unvollständige und unrichtige Angaben entsteht, haften und BINDER gegen eventuell entstehende Schadensansprüche Dritter freistellen.

We are aware that, in accordance with Article 823 of the German Civil Code (BGB), we are directly liable with regard to third parties, in this instance especially the employees of BINDER GmbH, who have been entrusted with the handling / repair of the unit / component. / Es ist uns bekannt, dass wir gegenüber Dritten – hier insbesondere mit der Handhabung/Reparatur des Geräts/des Bauteils betraute Mitarbeiter der Firma BINDER – gemäß §823 BGB direkt haften

Name: _____

Title/Position: _____

Date / Datum: _____

Signature / Unterschrift: _____

Company stamp / Firmenstempel:



Equipment that is returned to the factory for repair must be accompanied by a completely filled out contamination clearance certificate. For service and maintenance on site, such a contamination clearance certificate must be submitted to the service technician before the start of any work. No repair or maintenance of the equipment is possible, without a properly filled out contamination clearance certificate.

29.2 For chambers in the USA and Canada

Product Return Authorization Request

Please complete this form and the Customer Decontamination Declaration (next 2 pages) and attach the required pictures. E-mail to: IDL_SalesOrderProcessing_USA@binder-world.com

After we have received and reviewed the complete information we will decide on the issue of a RMA number. Please be aware that size specifications, voltage specifications as well as performance specifications are available on the internet at www.binder-world.us at any time.

Take notice of shipping laws and regulations.

	Please fill:	
Reason for return request	<input type="radio"/> Duplicate order	
	<input type="radio"/> Duplicate shipment	
	<input type="radio"/> Demo	<i>Page one completed by sales</i>
	<input type="radio"/> Power Plug / Voltage	115V / 230 V / 208 V / 240V
	<input type="radio"/> Size does not fit space	
	<input type="radio"/> Transport Damage	Shock watch tripped? (<i>pictures</i>)
	<input type="radio"/> Other (specify below)	

Is there a replacement PO?	<input type="radio"/> Yes <input type="radio"/> No	
<i>If yes -> PO #</i>		
<i>If yes -> Date PO placed</i>		
Purchase order number		
BINDER model number		
BINDER serial number		
Date unit was received		
Was the unit unboxed?	<input type="radio"/> Yes <input type="radio"/> No	
Was the unit plugged in?	<input type="radio"/> Yes <input type="radio"/> No	
Was the unit in operation?	<input type="radio"/> Yes <input type="radio"/> No	
<i>Pictures of unit attached?</i>	<input type="radio"/> Yes <input type="radio"/> No	Pictures have to be attached!
<i>Pictures of Packaging attached?</i>	<input type="radio"/> Yes <input type="radio"/> No	

	Customer Contact Information	Distributor Contact Information
Name		
Company		
Address		
Phone		
E-mail		

Customer (End User) Decontamination Declaration

Health and Hazard Safety declaration

To protect the health of our employees and the safety at the workplace, we require that this form is completed by the user for all products and parts that are returned to us. (Distributors or Service Organizations cannot sign this form)



NO RMA number will be issued without a completed form. Products or parts returned to our NY warehouse without a RMA number will be refused at the dock.

A second copy of the completed form must be attached to the outside of the shipping box.

1.	Unit/ component part / type:
2.	Serial No.
3.	List any exposure to hazardous liquids, gasses or substances and radioactive material
3.1	List with MSDS sheets attached where available or needed (if there is not enough space available below, please attach a page):
a)	_____
b)	_____
c)	_____
3.2	Safety measures required for handling the list under 3.1
a)	_____
b)	_____
c)	_____
3.3	Measures to be taken in case of skin contact or release into the atmosphere:
a)	_____
b)	_____
c)	_____
d)	_____
3.4	Other important information that must be considered:
a)	_____
b)	_____
c)	_____

4. Declaration of Decontamination

For toxic, radioactive, biologically and chemically harmful or hazardous substances, or any other hazardous materials.

We hereby guarantee that

- 4.1 Any hazardous substances, which have come into contact with the above-mentioned equipment / component part, have been completely listed under item 3.1 and that all information in this regard is complete.
- 4.2 That the unit /component part has not been in contact with radioactivity
- 4.3 Any Hazardous substances were removed from the unit / component part, so that no hazard exists for a person in the shipping, handling or repair of these returned unit
- 4.4 The unit was securely packaged in the original undamaged packaging and properly identified on the outside of the packaging material with the unit designation, the RMA number and a copy of this declaration.
- 4.5 Shipping laws and regulations have not been violated.

I hereby commit and guarantee that we will indemnify BINDER Inc. for all damages that are a consequence of incomplete or incorrect information provided by us, and that we will indemnify and hold harmless BINDER Inc. from eventual damage claims by third parties.

Name: _____

Position: _____

Company: _____

Address: _____

Phone #: _____

Email: _____

Date: _____

Signature: _____



Equipment returned to the NY warehouse for repair must be accompanied by a completed customer decontamination declaration. For service and maintenance works on site, such a customer decontamination declaration must be submitted to the service technician before the start of work. No repair or maintenance of the equipment is possible without a completed form.